

GPS III PILOT



Owner's Manual & Reference



Software Version 2.05 or above

GARMIN International, Inc., 1200 E. 151st Street, Olathe, Kansas 66062 USA

Tel: 913-397-8200

Fax: 913-397-8282

GARMIN (Europe) Ltd., Unit 5, The Quadrangle, Abbey Park Industrial Estate, Romsey SO51 9AQ UK

Tel: 011-44-1794-519944

Fax: 011-44-1794-519222

GARMIN (Asia) Corp., 3F No.1, Lane 45, Pao-Hsing Road, Hsin Tien, Taipei, Taiwan R.O.C.

Tel: 011-886-02-2917-3773

Fax: 011-886-02-2917-1758

Web Site Address: www.garmin.com

© 1997-1999 GARMIN Corporation All rights reserved. Except as expressly provided herein, no part of this manual may be reproduced, copied, transmitted, disseminated or stored in any storage medium, for any purpose without the express written permission of GARMIN. GARMIN Corporation hereby grants permission to download a single copy of this manual and of any revision to this manual onto a hard drive or other electronic storage medium to be viewed and to print one copy of this manual or of any revision hereto, provided that such electronic or printed copy of this manual or revision must contain the complete text of this copyright notice and provided further that any unauthorized commercial distribution of this manual or any revision hereto is strictly prohibited.

Information in this document is subject to change without notice. GARMIN reserves the right to change or improve its products and to make changes in the content without obligation to notify any person or organization of such changes.

Thank You!

Thank you for choosing the GARMIN GPS III Pilot —the smallest, easiest-to-use GPS navigator for today's sophisticated aviator! The GPS III Pilot represents GARMIN's continuing commitment to provide a quality airborne navigation system in a versatile and user-friendly flexible design you'll enjoy for years. To get the most from your new GPS, take the time to read through this owner's manual in order to understand the operating features of the GPS III Pilot. This manual is organized into three sections for your convenience:

Section One (Getting Started) introduces you to the basic features of the unit and provides a quick-start orientation to the GPS III Pilot.

Section Two (Simulator Tour) provides a step-by-step lesson in how your new GPS III Pilot would operate in actual flight by utilizing the built-in simulator mode.

Section Three (Reference) provides details about the advanced features and operations of the GPS III Pilot by topic.

Before getting started with your GPS, check to see that your GARMIN GPS III Pilot package includes the following items. If you are missing any parts, please contact your dealer immediately.

Standard Package:

- GPS III Pilot Unit with Detachable Antenna
- Wrist Strap
- GPS III Pilot Owner's Manual
- Quick Reference Card
- Velcro™ Fasteners
- Mounting Bracket



INTRODUCTION

Cautions



CAUTION: The Global Positioning System (GPS) is operated by the government of the United States, which is solely responsible for its accuracy and maintenance. The system is subject to changes which could affect the accuracy and performance of all GPS equipment. Although the GPS III Pilot is a precision electronic NAVigation AID (NAVAID), any NAVAID can be misused or misinterpreted and, therefore, become unsafe.



WARNING: For vehicular applications, it's the sole responsibility of the owner/operator of the GPS III Pilot to secure the GPS unit so that it will not cause damage or personal injury in the event of an accident. For automotive use, do not mount the GPS III Pilot over airbag panels or in a place where the driver or passengers are likely to have an impact with it in an accident or collision. The mounting hardware provided by GARMIN is not warranted against collision damage or the consequences thereof.



WARNING: For vehicular operations, it is the sole responsibility of the operator of the vehicle to operate his or her vehicle in a safe manner, maintain full surveillance of all conditions at all times, and never become distracted by the GPS III Pilot to the exclusion of safe operating practices. It is unsafe to operate the GPS III Pilot while flying or driving. Failure by the operator of a vehicle equipped with a GPS III Pilot to pay full attention to operating the vehicle while the vehicle is in motion could result in an accident.



This device complies with Part 15 of the FCC limits for Class B digital devices. This equipment generates, uses, and can radiate radio frequency energy and, if not installed and used in accordance with the instructions, may cause harmful interference to radio communications. Furthermore, there is no guarantee that interference will not occur in a particular installation.

If this equipment does cause harmful interference to other equipment, which can be determined by turning the affected equipment off and on, the user is encouraged to try and correct the interference by relocating the equipment or connecting the equipment to a different circuit than the affected equipment. Consult an authorized dealer or other qualified service technician for additional help if these remedies do not correct the problem.

Operation is subject to the following conditions: (1) This device may not cause harmful interference, and (2) this device must accept any interference received, including interference that may cause undesired operation.

The GPS III Pilot does not contain any user-serviceable parts. Repairs should only be made by an authorized GARMIN service center. Unauthorized repairs or modifications could void your warranty and your authority to operate this device under Part 15 regulations.



INTRODUCTION

Limited Warranty

GARMIN Corporation warrants this product to be free from defects in materials and workmanship for one year from the date of purchase. GARMIN will, at its sole option, repair or replace any components which fail in normal use. Such repairs or replacement will be made at no charge to the customer for parts or labor. The customer is, however, responsible for any transportation costs. This warranty does not cover failures due to abuse, misuse, accident or unauthorized alteration or repairs.

THE WARRANTIES AND REMEDIES CONTAINED HEREIN ARE EXCLUSIVE AND IN LIEU OF ALL OTHER WARRANTIES EXPRESSED OR IMPLIED, INCLUDING ANY LIABILITY ARISING UNDER WARRANTY OF MERCHANTABILITY OR FITNESS FOR A PARTICULAR PURPOSE, STATUTORY OR OTHERWISE. THIS WARRANTY GIVES YOU SPECIFIC LEGAL RIGHTS, WHICH MAY VARY FROM STATE TO STATE.

IN NO EVENT SHALL GARMIN BE LIABLE FOR ANY INCIDENTAL, SPECIAL, INDIRECT OR CONSEQUENTIAL DAMAGES, WHETHER RESULTING FROM THE USE, MISUSE OR INABILITY TO USE THIS PRODUCT OR FROM DEFECTS IN THE PRODUCT. SOME STATES DO NOT ALLOW THE EXCLUSION OF INCIDENTAL OR CONSEQUENTIAL DAMAGES, SO THE ABOVE LIMITATIONS MAY NOT APPLY TO YOU.

To obtain warranty service, call the GARMIN Customer Service department (913-397-8200) for a returned merchandise tracking number. The unit should be securely packaged with the tracking number clearly marked on the outside of the package, and sent freight prepaid and insured to a GARMIN warranty service station. A copy of the original sales receipt is required as the proof of purchase for warranty repairs. GARMIN retains the exclusive right to repair or replace the unit or software or offer a full refund of the purchase price at its sole discretion. SUCH REMEDY SHALL BE YOUR SOLE AND EXCLUSIVE REMEDY FOR ANY BREACH OF WARRANTY.

INTRODUCTION

| | |
|-------------------|------|
| About This Manual | .i |
| Cautions | .ii |
| FCC Compliance | .iii |
| Limited Warranty | .iv |

GETTING STARTED

| | |
|------------------------|-----|
| Unit Features | .1 |
| Keypad Usage / Display | .2 |
| Battery Installation | .3 |
| What is GPS? | .4 |
| Initialization | .5 |
| Main Page Sequence | .7 |
| Satellite Status Page | .8 |
| Position Page | .9 |
| Map Page | .10 |
| HSI Page | .11 |
| Highway Page | .12 |
| Main Menu | .13 |

| | |
|----------------------------|-----|
| Viewing Database Info | .14 |
| Going to a Waypoint | .15 |
| Cancel GOTO / Active Route | .16 |

SIMULATOR TOUR17

REFERENCE

| | |
|-----------------------|-----|
| Satellite Status Page | .27 |
| Position Page | .32 |
| Map Page | .35 |
| HSI Page | .40 |
| Vertical Navigation | .44 |
| Highway Page | .46 |
| Waypoint Categories | .48 |
| Nearest Page | .53 |
| User Waypoints | .55 |
| GOTO | .61 |
| TracBack | .64 |
| Routes | .66 |
| Active Route Page | .70 |

INTRODUCTION

Table of Contents

| | |
|--|-----|
| Main Menu | 73 |
| Setup Functions | 76 |
| APPENDIX A: Mounting Instructions | 88 |
| APPENDIX B: Specifications | 90 |
| APPENDIX C: Wiring/Interfacing | 91 |
| APPENDIX D: Antenna/Remote Mounting | 92 |
| APPENDIX E: Messages | 93 |
| APPENDIX F: Map Datums | 95 |
| APPENDIX G: Navigation Terms | 98 |
| APPENDIX H: Index | 100 |

GETTING STARTED

Unit Features

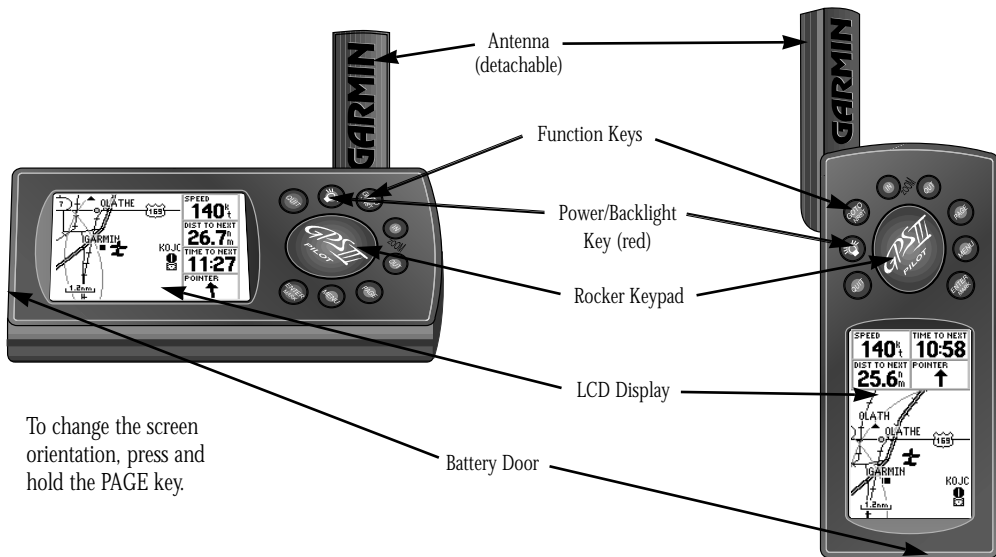

GETTING STARTED

Keypad Usage/Display



(POWER)— Red key turns the unit on and off, and controls three levels of screen backlighting intensity.



(PAGE)— Scrolls main pages in sequence and returns display from a menu/options page to a main page. Press and hold this key to change screen orientation.



(MENU)— Displays a menu of available options for the current page. Press twice to display the Main Menu.



(GOTO/NRST)— Displays the GOTO waypoint window, allowing you to select the destination waypoint. Press and hold this key to display the nine nearest airports, airspaces, nav aids, waypoints, etc.



(ENTER/MARK)— Activates highlighted fields and confirms menu options and data entry. Press and hold this key to mark present position as a waypoint.



(QUIT)— Returns the display to a previous page or restores a data field's previous value.



(IN and OUT)— Allows you to zoom in/out through 23 scales on the Map Page. Also adjusts scale on the Highway and HSI pages.



(ROCKER KEYPAD)— Controls the movement of the cursor, is used to select options and positions, and to enter data.

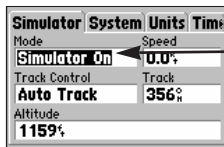

*Example of
Cursor high-
lighting the
'Mode' Field*

CURSOR— A solid black bar which can be moved up, down, left, and right with the keypad to select individual fields on the display (see above).

DEFAULT— A system-selected format, built into the operating software or the unit's memory, that will be followed unless the user chooses a different setting.

FIELD— The location on a page (see above) where a group of characters or option is entered and displayed.

HIGHLIGHT— The act of using the cursor to select a field for the purpose of entering data.

SCROLL— The act of moving through characters or options from a selected field.

DATA ENTRY— Entering data, such as waypoint names, typically begins and ends with the ENTER/MARK key. Use the rocker keypad to enter the actual data: UP/DOWN to change the highlighted character, RIGHT to move on to the next character.

The GPS III Pilot operates on 4 AA batteries, which are installed at the base of the unit. These batteries provide up to 24 hours of continuous use. Rechargeable NiCad or lithium batteries may also be used.



NOTE: The on-screen battery level indicator is calibrated for alkaline batteries, and will not be accurate when using NiCad or lithium batteries (see page 79).

To install the batteries:

1. Flip up the metal ring at the base of the unit, and turn the ring 90° counterclockwise.
2. Install the batteries and close the battery compartment door. When replacing the GPS III Pilot's batteries, observe the polarity markings engraved in the plastic case.
3. Lock the door in the closed position by rotating the metal ring 90° clockwise.

Battery life varies due to a variety of factors, including temperature and backlighting. You may find that the battery life varies in different conditions and that lithium batteries provide longer life in colder conditions. An internal 10-year lithium battery will retain your data while you're changing batteries.

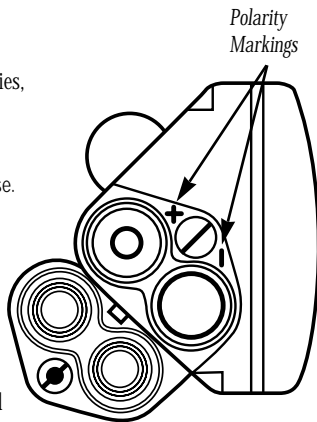

GETTING STARTED

What is GPS?

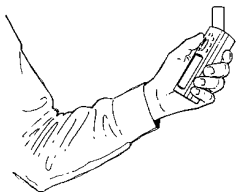

Hold the receiver at a comfortable height with the antenna pointing up.



When new (or if a position cannot be determined after 10 minutes), the GPS III Pilot will prompt you to initialize the receiver. The unit needs a starting position to determine which satellites are in view.

The Global Positioning System (GPS) is a system of 24 satellites which circle the earth twice a day in a very precise orbit and transmit information to earth. The GPS III Pilot must continuously “see” at least three of these satellites to calculate your position and track your movement. At times, additional satellites may be needed to determine a position.

By using an almanac (a timetable of satellite numbers and their orbits) stored in the receiver’s memory, the GPS III Pilot can determine the distance and position of any GPS satellite and use this information to compute your position.

Your GPS receiver can only see satellites above the horizon, so it needs to know what satellites to look for at any given time. To use this almanac data, your GPS needs to either be told its general location (“initialized”) or given the opportunity to find itself. Once you initialize the unit to a position, it will typically compute a fix within a few minutes. We’ll show you how to initialize your new GPS III Pilot on page 5.

Initialization is only necessary under the following conditions:

- The first time you use your receiver (new from the factory).
- After the receiver has been moved over 500 miles (with the power off) from the last time you used it.
- If the receiver’s memory has been cleared and all internally stored data has been lost.

Because the GPS III Pilot relies on satellite signals to provide you with navigation guidance, the receiver needs to have an unobstructed, clear view of the sky for best performance. In a nutshell, the GPS receiver’s view of the sky will generally determine how fast you get a position fix—or if you get a fix at all. GPS signals are relatively weak and do not travel through rocks, buildings, people, metal, or heavy tree cover, so remember to keep a clear view of the sky at all times for best performance.

Once the GPS III Pilot has calculated a position fix, you'll usually have anywhere from five to twelve satellites in view. The receiver will then continuously select the best satellites in view to update your position. If some of the satellites in view get blocked or "shaded," the receiver can simply use an alternate satellite to maintain the position fix. Although a GPS receiver needs four satellites to provide a three-dimensional (3D) fix, it can maintain a two-dimensional (2D) fix with only three satellites. A three-dimensional fix means the unit knows its latitude, longitude, and altitude, while a two-dimensional fix means the unit knows only its latitude and longitude.

Initializing Your GPS III Pilot

To initialize the GPS III Pilot, take the receiver outside and find an open area where the antenna has a clear view of the sky. You may either hold the receiver at a comfortable height with the antenna pointing up (see page 4), or mount the receiver on the dash of a vehicle, as described in Appendix A. (Likewise, when you use your GPS III Pilot in a vehicle, make sure the antenna is pointing up.)

To turn the GPS III Pilot on, press and hold the red power key.

The Welcome Page will be displayed while the unit conducts a self test. Once testing is complete, the Welcome Page is replaced by the Database Page (which shows the effective date for the Jeppesen database), followed by a warning page, then by the Satellite Status Page. A message will inform you to "select initialization method." (If the initialization prompt has not automatically appeared, press MENU and select 'Initialize Position'.)

To initialize your unit:

1. Press ENTER to acknowledge the message. A window will appear prompting you to select an initialization method.
2. Use the rocker keypad to highlight 'Use Map', and press ENTER.
3. Use the rocker keypad to point the map cursor to your approximate location (within at least 250 miles). You may also wish to use the IN and OUT zoom keys to make it easier to identify your approximate position.
4. Press ENTER to select the position and begin searching for satellites.

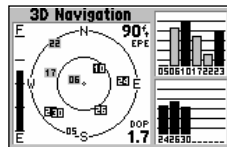

Check the Satellite Status Page for '2D Navigation' or '3D Navigation' to verify a position fix.



The Welcome Page is displayed when the GPS III Pilot is first turned on. During this time the receiver is conducting a self-test.

GETTING STARTED

Initialization



To initialize the GPS III Pilot, designate your approximate location directly on the map display. Use the rocker keypad and IN/OUT zoom keys to position the cursor on the map.

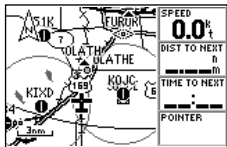

Once the GPS III Pilot has a position fix, it will automatically transition from the Satellite Status Page to the Map Page.

This usually provides a position fix in one minute. You'll know you have a fix when the unit automatically transitions from the Satellite Page to the Map Page (shown bottom left). Your receiver is now ready to use!

To turn the unit off:

1. Press and hold the red power key for one second.

Troubleshooting

If you have trouble initializing or getting a position fix, check the following:

- **Does the receiver have a clear view of the sky?**

If there are large buildings or mountains, or if there is heavy tree cover, the receiver may not be receiving enough satellite signals to calculate a fix. Also, if you're using the GPS III Pilot inside the cockpit, make sure the unit is placed so that it has the clearest possible view of the sky. Your GPS will only be able to detect satellites that it can "see" through your vehicle's windshield. Depending on the slope of glass or the overall surface area, it may be necessary to remote mount an antenna inside the cockpit or install an outside antenna. (Contact your local GARMIN dealer and inquire about the GA 26 Remote Antenna, part number 010-10052-02, or the GA 56 Low Profile Antenna, part number 010-10040-01.)

- **Have you selected the right area when initializing?**

Check for the correct approximate position on the Map Page (press PAGE until the Map Page appears; see pages 7 and 10), or reselect your approximate location to restart the initialization.

- **Have you moved more than 500 miles from the last calculated position with the receiver off?**

Reinitialize the receiver by selecting your approximate position on the map, or select 'AutoLocate' from the Satellite Status Page Options (see page 31).

GETTING STARTED

Satellite Status Page

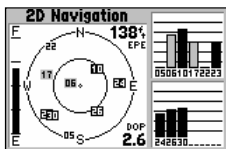

The signal strength bars give you an indication of what satellites are visible to the receiver, whether or not they're being used to calculate a position fix, and the signal quality.

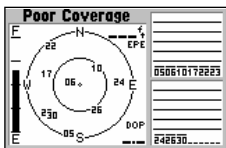

If satellite reception is lost, or an insufficient number of satellites are available, you will be alerted with a 'Poor Coverage' receiver status and message.

Let's start with the Satellite Status Page, which is the page you'll view while your unit is getting a position fix. If you're not already on this page, press PAGE or QUIT until it appears. The Satellite Status Page shows you status information that helps you understand what the receiver is doing at any given time, and it's a page that you'll want to occasionally refer back to as you use your unit. It features a sky view of available satellites, corresponding signal strength bars, the status of your current position fix (acquiring, 2D, 3D, etc.), and your estimated position error (EPE). You can also tell how much battery power is remaining, and you can adjust the screen contrast by pressing the rocker keypad.

Satellites are indicated on the sky view and the signal strength bars by their corresponding number, from 01 through 32. The sky view shows where it is looking in the sky for each satellite, by indicating the direction and elevation (angle above the horizon). The signal strength bars depict the relative strength of the signal from each satellite being received. The taller the bar, the stronger the signal.

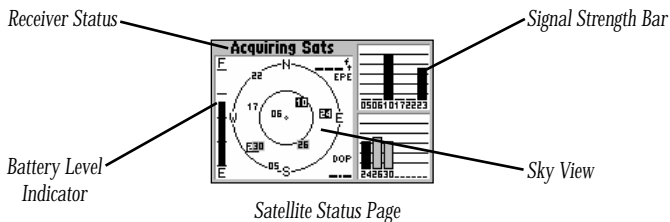

Satellite Status Page

GETTING STARTED

Position Page

The Position Page shows you where you are, what direction you're heading, and how fast you're going—and it's a page you may want to use when you don't have a destination selected.

A graphic compass display at the top of the page shows your direction of travel (track) while you're moving, while six user-selectable data fields below display your current speed, average speed, trip odometer, trip timer, and sunrise/sunset times at your current position. "User-selectable" means you can change them to display other navigation information. We'll cover these fields more in the reference section.

Below the user-selectable data fields are additional data fields to display your current position, along with current time and date. The current position readout can be in latitude/longitude, UTM/UPS, Maidenhead or one of several regional grids. Current time and date can be in local time or UTC (Coordinated Universal Time, or "zulu" time).

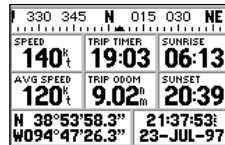
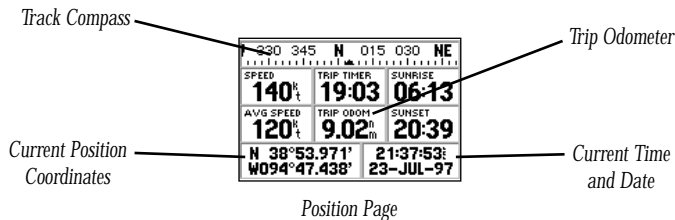

Position Page showing current position in degrees, minutes and seconds.



The trip odometer, trip timer and average speed readings can all be reset from the 'Trip Computer' option on the Main Menu. See page 75.

GETTING STARTED

Map Page

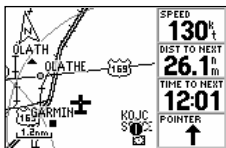

With the map oriented to 'Track Up', the pointer always points up and the map rotates to your current direction of travel (track). Note the north indicator on the map.



You can also select a full-screen map from the Map Page Options. See page 37.

The Map Page shows your movement using a real-time track log (an electronic breadcrumb trail that appears directly on the map as you're traveling), and your present position as an airplane icon in the center of the map. The Map Page also shows any nearby airspace boundaries, lakes, rivers, highways and towns. The map scale is shown in the lower left-hand corner of the map. Use the zoom keys (IN and OUT) to adjust the map to the desired scale.

To change the map scale:

1. Press the IN zoom key to select a smaller scale and more detail for a smaller area.
2. Press the OUT zoom key to select a larger scale and display a larger area.

The map can be oriented with the top of the page always pointing north, oriented along your desired course, or it can automatically rotate to keep your current direction of travel (track) at the top of the screen. 'North Up' is the default setting.

Nearby airports, VORs, NDBs, intersections and user waypoints are depicted on the map (each with its own unique symbol) with the identifier listed directly above the waypoint's symbol. We'll cover more about the GPS III Pilot's waypoint features and the Map Page in the reference section of this manual.

Nearby Navaid
(Intersection)

Present Position

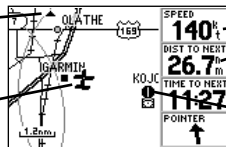

Data Fields

Nearby Airport

Map Page

GETTING STARTED

HSI Page

The GPS III Pilot features two different navigation pages: HSI (horizontal situation indicator) and Highway. The HSI Page is first. The HSI Page provides graphic steering guidance to a destination waypoint and will likely become your primary navigation screen. (The Highway page also provides graphic steering guidance by displaying a three-dimensional perspective of your course and the surrounding area.) The HSI graphically depicts a mechanical HSI, showing the desired course using a 'D-bar' (course deviation bar; which is part of the course deviation indicator, or 'CDI') and course pointer. If you move off course, the D-bar will indicate off course distance and direction. To return to the desired course, simply steer in the direction of the D-bar until it returns to the center of the CDI. The CDI scale is adjustable, with the current scale indicated at the bottom of the page. The scale setting represents the distance from the center of the CDI to full left or right limits.

The HSI depicts your (ground) track heading using a rotating 'compass card'. Don't confuse this with the aircraft heading indicated on your panel. On a windy day these two figures can differ significantly!

The HSI page also provides a TO/FROM indication and vertical guidance, when using the unit's vertical navigation (VNAV) features. Four user-selectable data fields indicate current speed, distance to destination, time en route and time of day.

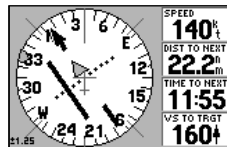

If you move off course, steer in the direction of the D-bar until it returns to the center of the CDI.

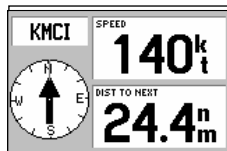

The 'Big Numbers' option (available from the HSI Page Options) shows a smaller compass-type display and larger data field characters. See page 42.

GETTING STARTED

Highway Page

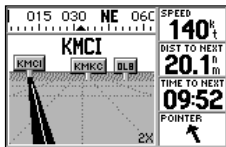

If you move off course, the highway display will move, indicating the direction you are off course. To stay on course, simply move toward the center of the highway.

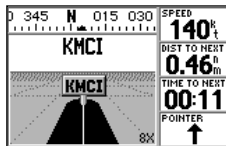

As you approach your destination, the graphic highway will stop at the destination waypoint. You have arrived when the waypoint is at the bottom center of the display.

The GPS III Pilot's Highway Page also provides graphic steering guidance to a destination waypoint. As you head toward your destination, the middle of the screen provides visual guidance to your waypoint on a moving graphic "highway." Your present position is at the bottom center of the highway display. The line down the middle of the highway represents your desired course. As you navigate toward a waypoint, the highway will actually move—indicating the direction you're off course. To stay on course, simply move toward the center of the highway.

The top of the page indicates speed and distance to your destination (or the next waypoint in a route), along with a track compass showing current direction of travel. Directly below the distance reading is the time required to reach your destination (or the next waypoint in a route), in hours/minutes or minutes/seconds. The pointer at the bottom of the page also shows the bearing to your destination, relative to your current track. If the pointer points straight ahead, you're heading directly to your destination!

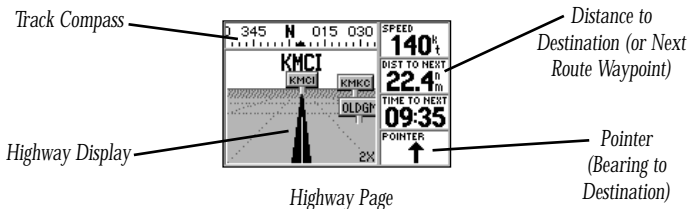

Highway Page

Main Menu

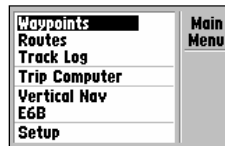

The GPS III Pilot's Main Menu provides access to an additional set of pages that are used to create or edit waypoints, create routes, review track log or trip information, configure the vertical navigation features, perform E6B calculations or make changes to system settings. These seven menu items are divided into categories by function. The waypoint and route management features of the Main Menu are described in more detail in the Reference section of this manual. Let's take a look at the Main Menu and one of its options.

To view the Main Menu:

1. Press the MENU key twice.

To select an item from the Main Menu:

1. Highlight the desired item using the rocker keypad, and press ENTER.
2. To return to the Main Menu, press QUIT.

The 'Setup' option provides a list of choices (presented as a series of 'file tabs') to perform various configuration settings including system settings, selection of position format and units of measure, time display, setting various alarms, enabling the built-in simulator feature and interface options with other equipment:

To change units of measure for distance and speed:

1. Select the 'Setup' option from the Main Menu (as described above), and press ENTER.
2. Highlight the 'Units' tab with the rocker keypad. The units settings are automatically displayed.
3. Highlight the 'Distance & Speed' field using the rocker keypad, and press ENTER. A pop-up menu appears showing the available options.
4. Select the desired option using the rocker keypad, and press ENTER.

The Main Menu provides access to additional pages, including database information, flight plans (routes), trip information and unit settings.

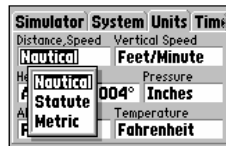

The 'Setup' option provides a list of menu choices to perform various configuration settings, such as changing units of measure for distance and speed.

GETTING STARTED

Viewing Database Info

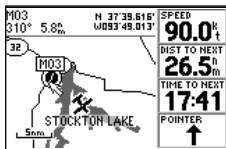

To view database information directly from the map, place the panning cursor on the desired item and press ENTER.

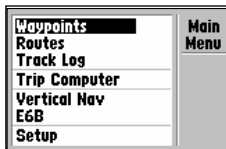

To view database information by manually entering the identifier, name or city, select the 'Waypoints' option from the Main Menu.

One of the most important features of the GPS III Pilot is the built-in Jeppesen database, which includes information on airports, runways, communication frequencies, VORs, NDBs, intersections and airspace boundaries. This information is readily available directly from the map, or from the 'Waypoints' option on the Main Menu.

To view the database information from the Map Page:

1. With the Map Page displayed, use the rocker keypad to place the panning cursor over the desired facility on the map. When the cursor is directly over the desired item, the identifier for that item is highlighted. (For airspace information, place the cursor over any open area within the boundary of the desired airspace.)
2. Press ENTER to view the database information for the selected facility/airspace. If an airport was selected, use the rocker keypad to select the 'Airport', 'Runway' or 'Comm' information pages for that airport.

To view the database information by entering the identifier, name or city for the desired facility:

1. Press MENU twice to display the Main Menu.
2. Highlight 'Waypoints' and press ENTER. A series of tabs appear for each category of waypoint information: airports, runways, comm frequencies, VORs, NDBs, intersections, user-entered waypoints. Select the desired category using the rocker keypad.
3. To view information by identifier, highlight the identifier field and press ENTER. Enter the identifier, using the rocker keypad, and press ENTER to display the information.
4. To view information by facility name or city (only applicable to the 'Airport', 'VORs', and 'NDBs' information pages), highlight the appropriate field and press ENTER. Enter the name/city using the rocker keypad, and press ENTER to display the information.

The GPS III Pilot's GOTO feature allows you to quickly and easily navigate to any airport, navaid or user-entered waypoint stored in memory. A GOTO is really nothing more than a straight-line course from your present position to the destination you've selected. A GOTO can be performed several ways: by specifying the destination from the GOTO Page, graphically from the map display or by highlighting the waypoint name on any page (such as the Nearest Page).

To select a GOTO destination from the GOTO Page:

1. Press GOTO/NRST. This captures your current position as the starting point for your trip.
2. Highlight the identifier field at the top of the page and press ENTER. This allows you to enter the identifier for any waypoint position stored in memory.
3. Use the rocker keypad to enter the identifier for the desired waypoint and press ENTER.

To select a GOTO destination from the Map Page:

1. With the Map Page displayed, use the rocker keypad to place the cursor over the desired destination waypoint. (If no waypoint exists at the destination location, the GPS III Pilot will automatically create one, named 'MAP' in the step below.)
2. Press GOTO/NRST, and then ENTER to navigate to the selected location.

To GOTO a listed waypoint on the Nearest Page:

1. Press and hold the GOTO/NRST key to display the Nearest Page.
2. Use the rocker keypad to select a tab for the desired waypoint category (e.g. 'Airport').
3. Use the rocker keypad to highlight the desired waypoint, press GOTO/NRST and ENTER.

Once the GOTO destination is selected, use the Map Page, HSI Page and/or Highway Page to keep track of your progress as you head toward your destination.



To select the GOTO destination from a list of all user waypoints or from a list of recently used waypoints, select the 'User' or 'Recent' tabs.

| Airports | VORs | NDBs | Ints | Use |
|-------------|---------|----------|------|-----|
| Waypoint | Bearing | Distance | | |
| 51K | 247° | 6.47 | | |
| KOJC | 170° | 7.19 | | |
| RTXD | 214° | 10.3 | | |
| 63K | 139° | 11.1 | | |
| KGVM | 125° | 11.7 | | |

To GOTO one of the listed 'Nearest Waypoints', highlight the desired waypoint, press GOTO/NRST and then ENTER.

GETTING STARTED

Cancel GOTO/Active Route



To cancel the current GOTO destination, select 'Cancel GOTO' from the GOTO Options Page.

| KIXD-KOSH | | Active Route |
|-----------|------------------|--------------|
| Waypoint | Distance | |
| KIXD | n | |
| ▶KCID | 207 ^m | |
| KOSH | 395 ^m | |
| ----- | n | |
| ----- | n | |
| TOTAL | 395 ^m | |

Use the LEFT/RIGHT keys on the rocker keypad to select the desired data item. Available items include course, distance, fuel, and sunrise/sunset times.

To cancel the current GOTO destination, simply select another destination. If no destination is currently desired, or you want to resume a previously selected route, the GOTO operation may be cancelled from the GOTO Options Page.

To cancel the current GOTO destination:

1. Press GOTO.
2. Press MENU.
3. Highlight 'Cancel GOTO' and press ENTER.

Active Route Page

The last of the six main pages is the Active Route Page. This page shows the GOTO waypoint or each waypoint of a route, with waypoint name and the course along each leg (segment) of the route. When using a route, the current destination is marked with an arrow on the left-hand side of the screen. If no destination has been specified using the GOTO key or a route, no waypoints will be listed on the page. (For more information on using routes, see page 66 in the Reference section.)

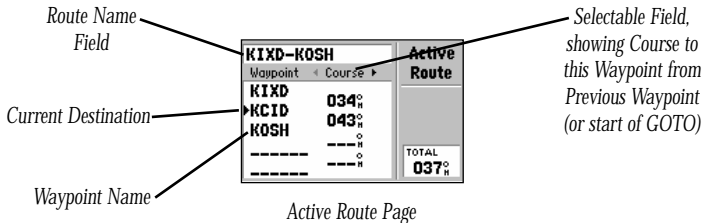

Active Route Page

The GPS III Pilot is a powerful navigation system providing detailed mapping information in a convenient, compact package. This simulator tour is designed to show you the basic features of your new GPS III Pilot during a simulated trip. The simulator tour assumes that the receiver has been properly initialized as outlined in the Getting Started section of this manual, and that you have not changed any of the factory default settings. If you have changed any settings (position formats, units of measure, etc.), the descriptions and pictures in the tour may not match your configuration.

Once you're familiar with the primary functions of the GPS III Pilot, you'll be ready to use your new receiver on a real trip to a destination of your choice. The Reference section of this manual may be consulted for any additional questions you may have, or to learn about the more advanced features of the GPS III Pilot. For now, let's get started on the Simulator Tour!

If the GPS III Pilot is currently off, you'll need to start by turning it on.

To turn the GPS III Pilot on, press and hold the red power key.

The Welcome Page will be displayed while the unit conducts a self test. Once testing is complete, the Welcome Page is replaced by the Database Page, then by a warning page, and finally by the Satellite Status Page. Since we'll be using the simulator mode, we don't need to wait for the receiver to acquire satellites.



WARNING: Keep in mind that the GPS III Pilot does not track satellites in simulator mode and this mode should never be used for actual navigation. The GPS III Pilot cannot be turned on in simulator mode. If you forget to change back to normal operation before shutting the receiver off, it will automatically return to normal mode the next time you use the receiver.



The Welcome Page is displayed when the GPS III Pilot is turned on. After a brief self-test, it is replaced by database and warning pages. To skip these pages, press ENTER.

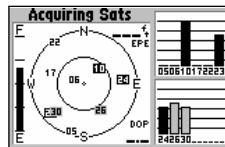

The Satellite Status Page appears next. For simulator mode operations, there's no need to wait for the GPS III Pilot to acquire satellites.

SIMULATOR TOUR

Selecting Simulator Mode



Select 'Start Simulator' from the Satellite Status Page Options to enable the built-in simulator.

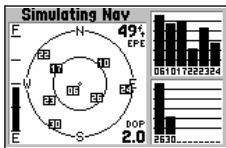

The simulator imitates satellite reception and shows that information on the Satellite Status Page. Remember, in this mode the GPS III is **not** actually tracking satellites.

To select the simulator mode:

1. Press MENU to list the options for the Satellite Status Page.
2. Highlight 'Start Simulator' with the rocker keypad, and press ENTER.
3. Press ENTER to acknowledge the warning message.

Let's look at the sequence of pages again. The PAGE and QUIT keys are used to find your way around on the GPS III Pilot.

To cycle through the main pages:

1. Press PAGE to move through each of the main pages in normal fashion.
2. Press QUIT to sequence through the main pages in reverse order.

In normal mode operation, the GPS III Pilot would automatically sequence from Satellite Status Page to Map Page once enough satellites were received to determine your position. At that point the receiver is ready to use for navigation. Since we're in simulator mode we won't see that automatic sequence of steps, but as you cycle through the main pages, notice that the simulator imitates satellite reception and shows that information on the Satellite Status Page.

The Position Page will show the last known position as a starting location. If you've already initialized the receiver, as outlined in the Getting Started section, the starting location should be very close to your current position! We'll use this starting location from which to begin our simulated trip. Let's move on to the Map Page to see where we are, select a GOTO destination and explore the navigation features of the GPS III Pilot.

To select the Map Page, press PAGE repeatedly until it appears.

SIMULATOR TOUR

Using the Map Page

The GPS III Pilot's Map Page combines digital charts and Jeppesen data with a number of user-selectable features. Before we select our destination and begin navigating toward it, let's take a look at some of those features.

Background Cities,
Roads and Lakes

Current Scale
Setting

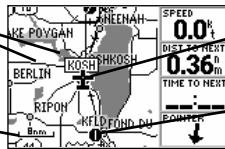

Present Position

Nearby Airport

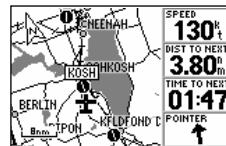

The map display shows your present position using an airplane icon in the center of the screen. The Map Page also shows any nearby airports, nav aids, airspace boundaries, lakes, rivers, highways and towns. Use the zoom keys (IN and OUT) to adjust the map to the desired scale. The current scale is indicated in the lower-left corner.

To change the map scale:

1. Press the IN zoom key to select a smaller scale and display a smaller geographic area.
2. Press the OUT zoom key to select a larger scale and display a larger geographic area.

The map can be oriented with the top of the page always pointing north ('North Up'), oriented along your desired course ('Course Up'), or it can automatically rotate to keep your current direction of travel at the top of the screen ('Track Up').

Let's try panning around on the map display to see how that process works, and then we'll find a nearby airport, VOR, NDB or intersection and navigate to it. First we will need to select an appropriate map scale to begin our search.

Select a five nautical mile scale by pressing zoom IN or OUT repeatedly.

In the 'Track Up' orientation, the map is automatically rotated to keep your current direction of travel at the top of the screen. Note the north indicator in upper-left corner.

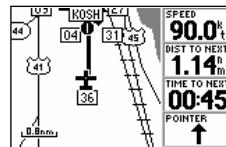

Use the IN/OUT zoom keys to change the map scale. The current scale appears in the lower-left corner of the map display.

SIMULATOR TOUR

Viewing Waypoint Info



Use the rocker keypad to pan to other areas on the map display. When panning, an on-screen cursor appears for reference.



Place the cursor over an on-screen airport or navaid to highlight the item, then press ENTER to view database information for the selected item.

Working from the Map Page is a simple process that centers around the use of the cursor. Controlled by the rocker keypad, the cursor is an important tool allowing you to pan to other areas on the map display, view waypoint information, create waypoints, specify a GOTO target and create routes. To get a feel for using the Map Page and the cursor, try the following exercise:

1. Using the rocker keypad to move the cursor, try following a highway (or other feature) near your position. Simply press and hold one side of the rocker keypad to move more quickly. Notice how a data field appears above the map, showing the bearing and distance from present position to the cursor, along with the latitude/longitude of the cursor.
2. Using the rocker keypad, continue moving the cursor in any direction until you find an airport or navaid. Once you find one, place the cursor over that waypoint so that its identifier is highlighted.
3. Press ENTER to view the database information for the selected waypoint. If an airport is selected, use the LEFT/RIGHT keys on the rocker keypad to select between 'Airport', 'Runway' and 'Comm' information pages.

'File Tabs' for other info types

Waypoint Identifier Field

| Airport | Runway | Comm | VOR | NDB | Int |
|---------------------|----------------|--------------|-----|------|--------|
| KATW | | | | | Public |
| ELEV 920' | FUEL Av Jet Mo | | | | |
| OUTAGAMIE CO | | | | | |
| APPLETON WI | | | | | |
| N 44°15.444' | | W088°31.165' | | Done | |

Waypoint Symbol Field

Waypoint Position

4. When finished reviewing the information press QUIT to return to the Map Page. (Pressing QUIT a second time will end the panning operation and return the map to your present position. For now, we'll stay in panning mode and leave the selected waypoint highlighted on the map.)

Now that we've seen how to find waypoints on the map and view information about them, let's see how the GPS III Pilot is used to navigate to the waypoint we just selected. (Keep in mind that the cursor can also be used to GOTO any point on the map—even without a waypoint already at that location—by simply panning to a location and pressing GOTO/NRST. A waypoint named 'MAP' is automatically created. We won't try that here, but you might want to experiment with this procedure at the end of the Simulator Tour.)

To select the highlighted waypoint as a GOTO destination, press GOTO/NRST and ENTER.

Notice that a course line appears on the map display showing the way to our destination, panning mode is automatically cancelled and the map re-centers itself around your present position. Now that we have our destination selected, it's about time we get started—so let's plug a speed into this simulator to animate the displays!

To enter a simulated speed and animate the displays:

1. Press PAGE repeatedly until the HSI Page appears (see page 22).
2. Enter a simulated speed of '100' (knots) using the rocker keypad. (Press UP on the rocker keypad repeatedly to select '100'. The speed readout is on the upper-right corner of the HSI Page.)
3. Press PAGE (or QUIT) repeatedly to return to the Map Page.

Notice the information on the map display is slowly moving? That's how it would look in actual use as well. The background map information, airports, nav aids and airspace boundaries will move across the screen, while your current position remains fixed in the center.



To select a GOTO destination from the map, highlight the desired waypoint, press GOTO/NRST and then ENTER.

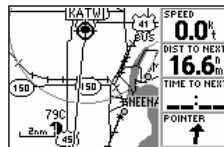

Once the GOTO destination is selected, a course line appears on the map display and the map re-centers itself around your current position.

SIMULATOR TOUR

HSI Page



From the HSI Page, you can increase/decrease the simulated speed using the UP/DOWN keys on the rocker keypad.

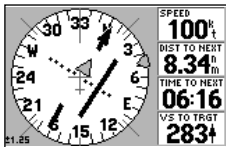

To move off course in simulator mode, use the LEFT/RIGHT rocker keypad keys.

The other primary navigation screens are the HSI and Highway pages, with the HSI Page appearing first in the sequence of main pages.

To view the HSI Page, press PAGE.

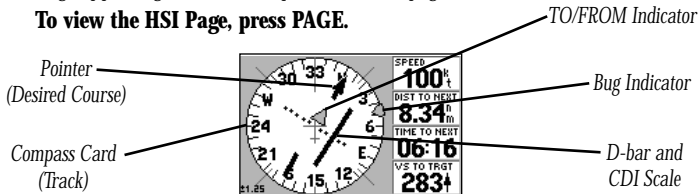

The HSI Page provides graphic steering guidance to your destination waypoint. The page features a graphic HSI (horizontal situation indicator), including a rotating 'compass card' that shows your course over ground (track) while you're moving, a course pointer and CDI (course deviation indicator) which indicate the desired course to your destination. The compass card, pointer arrow and CDI work independently to show—at a glance—the direction you're travelling, the desired course and whether or not you are off course.

At the center of the CDI is a 'D-bar', or course deviation bar. If you move off course, the D-bar will indicate how far off course you are and in what direction. The scale for the CDI is indicated at the bottom of the page. The scale represents the distance from the center of the CDI to full left or right limits.

As you approach the waypoint, a TO/FROM indicator will signal waypoint crossing. The current speed, distance to the next waypoint, time to the next waypoint and vertical speed to target are all displayed to the right of the graphic HSI. To see how all this works on our simulated trip, let's head off course and watch the displays change.

To move off course/on course in simulator mode, use the LEFT/RIGHT keys on the rocker keypad.

SIMULATOR TOUR

Highway Page

The GPS III Pilot's Highway Page provides a graphic highway display that shows your movement relative to the desired course. The line down the middle of the highway represents your desired course. As you navigate toward your destination, the highway will actually move, indicating the direction you're off course. To stay on course, simply steer toward the center of the highway. As you approach the waypoint, the highway will end at the final destination. When the waypoint marker is at the bottom center of the highway display, you've arrived at your destination.

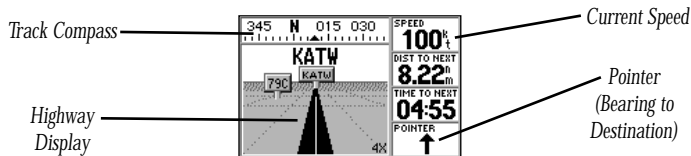

The distance to the next waypoint, time to the next waypoint and current speed are displayed to the right of the highway display. A track compass also shows your current track directly above the highway display, making it easy to see at a glance what you're headed.

The pointer arrow at the bottom of the page indicates the direction to the destination waypoint (bearing) relative to the direction you are moving (track). If the pointer points straight ahead, you're heading directly to the waypoint. If not, turn in the direction of the pointer and the pointer will swing around, pointing straight ahead as you begin moving toward the destination waypoint. Let's try changing the course again and see how the highway display changes.

To move off course/on course in simulator mode, use the LEFT/RIGHT keys on the rocker keypad.

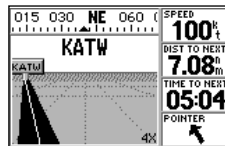

If you move off course, the highway moves to indicate the direction you're off course. To return to the course, steer toward the highway centerline.

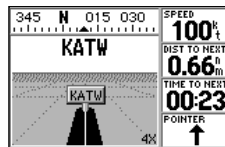

As you approach your destination, the highway will end at the destination waypoint.

SIMULATOR TOUR

Marking Present Position

| Mark Waypoint | |
|----------------------|---|
| 001 | ■ |
| CRTD 15:34 22-MAR-99 | |
| REF | ----- |
| BRG | 000° _H DST 0.00 _m |
| N 44°15.362' | |
| W088°31.178' | |
| Done | |

Press and hold the ENTER/MARK key to save your present position as a user waypoint.

| Waypoint Symbol | |
|-----------------|----------------|
| 00 | ⬇ Golf Course |
| CR | Ⓜ Heliport |
| REF | 🏠 Hotel |
| BRG | 🏹 Hunting Area |
| N | 📄 Information |
| W088 | |

User waypoints can be assigned a custom symbol, making it easy to identify the waypoint on the Map Page.

Imagine you've just departed. Your home airport is thirty minutes behind you. You fly over a nice fishing lake or golf course you've never noticed before and decide you would like to return to this place in your car. How would you mark this spot? The GPS III Pilot's ENTER/MARK key provides a simple way to mark your present position and save it as a waypoint.

To mark your present position:

1. Press and hold the ENTER/MARK key. The mark position page will appear, with a default three-digit name for the new waypoint in the upper-left portion of the page.
2. Let's call this location 'SIMUL8'. To change the name, highlight the waypoint name field (at the top of the page) and press ENTER. Use the rocker keypad to enter the new name — UP/DOWN to change the first character ('S'), RIGHT to move to the next character ('1'), and repeat. Press and hold UP or DOWN to cycle through the characters more quickly. Once the new name is spelled out, press ENTER to accept it.

Waypoint Name
Field

Position
Coordinates

| Mark Waypoint | |
|----------------------|---|
| SIMUL8 | ■ |
| CRTD 15:34 22-MAR-99 | |
| REF | ----- |
| BRG | 000° _H DST 0.00 _m |
| N 44°15.362' | |
| W088°31.178' | |
| Done | |

Waypoint
Symbol Field

3. Now let's use a special symbol to identify the location. Highlight the waypoint symbol field (immediately right of the name field) and press ENTER. Use UP/DOWN on the rocker keypad to select the 'Information' icon (?) and press ENTER.
4. To save the new waypoint, highlight 'DONE' with the rocker keypad and press ENTER.

Suppose another thirty minutes into your flight you experience an emergency and need to find a place to land. Or, you just want to stop for a break at a nearby airport or top off the tanks. A list of the nine nearest airports within 200 miles of your present position is just a keystroke away! Instantly, you can select an airport from the list and designate it as your destination waypoint. Or, you can review all the available Jeppesen data for that particular airport. Let's take a look at the closest airports in your area.

To view the nine nearest airports:

1. Press and hold the GOTO/NRST key. The Nearest Page will appear.
2. Using the LEFT/RIGHT keys on the rocker keypad, select the 'Airports' tab to see up to nine nearest airports, along with bearing and distance to each.

To GOTO a nearest airport:

1. Using the UP/DOWN keys on the rocker keypad, highlight the desired airport.
2. Press GOTO/NRST, followed by ENTER, to designate the airport as your destination.

To view the Jeppesen data for a nearest airport:

1. Using the UP/DOWN keys on the rocker keypad, highlight the desired airport.
2. Press ENTER to view the waypoint information pages.
3. Use the LEFT/RIGHT keys on the rocker keypad to select the 'Airport', 'Runway' or 'Comm' information pages.

| Airports | VORs | NDBs | Ints | Use |
|----------|---------|----------|------|-----|
| Waypoint | Bearing | Distance | | |
| 79C | 319° | 1.53 | | |
| KATH | 008° | 7.00 | | |
| KOSH | 188° | 9.49 | | |
| M34 | 359° | 18.9 | | |
| 8D1 | 125° | 21.7 | | |

Press and hold the GOTO/NRST key to view the Nearest Page. Select the 'Airports' file tab to see the nine nearest airports.

| Airports | VORs | NDBs | Ints | Use |
|-------------|---------|----------|------|-----|
| Waypoint | Bearing | Distance | | |
| 79C | 319° | 1.53 | | |
| KATH | 008° | 7.00 | | |
| KOSH | 188° | 9.49 | | |
| M34 | 359° | 18.9 | | |
| 8D1 | 125° | 21.7 | | |

To GOTO a nearest airport, highlight the desired airport using the rocker keypad, press GOTO/NRST, then ENTER.

SIMULATOR TOUR

Airspace Warnings



When you are projected to enter an airspace, the first alert is typically 'Airspace Ahead Less Than 10 minutes'.

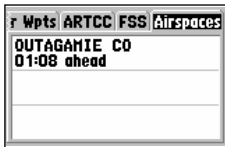

To view additional information about the airspace alert, press and hold the GOTO/NRST key and select the 'Airspace' file tab.

As you continue along your route, you may pass in close proximity to, or enter, an airspace. Whenever you are within 2 nm, projected to enter, or inside an airspace, the GPS III Pilot will notify you with a message and supply detailed information about each airspace you are being alerted to. Look closely at the map display. If you see an airspace ahead of your present course, you may be alerted with a message as you approach it.



NOTE: The airspace alert occurs when your current altitude places you within the floor and ceiling limits of the airspace. If you are several hundred feet, or more, below or above these limits, the GPS III Pilot will not bother you with an alert, but the airspace boundary will still appear on the Map Page.

To view detailed information about an airspace alert:

1. Press and hold the GOTO/NRST key.
2. Use the LEFT/RIGHT keys on the rocker keypad to highlight the 'Airspace' tab.
3. Use the UP/DOWN keys to highlight the desired airspace (if more than one is listed) and press ENTER.

That's it! You've covered the basics and you're ready to venture off on your own. Operating the GPS III Pilot is just as simple as you've seen here in the Simulator Tour, but in real applications you won't need to change speed and track with the rocker keypad. That's all done automatically utilizing information from the GPS satellites as you move about.

Before ending the tour, try a few experiments of your own, such as going to the 'SIMUL8' waypoint or experimenting with the vertical navigation features (see page 43). Use the Reference section of this manual for more ideas.

To end the Simulator Tour, turn the GPS III Pilot off with the power key.

The GPS III Pilot's Satellite Status Page provides a visual reference of various receiver functions, including current satellite coverage, receiver status, battery level and position accuracy. As the receiver locks onto satellites, a signal strength bar will appear for each satellite in view, with the appropriate satellite number (01-32) underneath each bar. The progress of satellite acquisition is shown in three stages:

- No signal strength bars— the receiver is looking for the satellites indicated.
- Hollow signal strength bars— the receiver has found the satellite(s) and is collecting data.
- Solid signal strength bars— the receiver has collected the necessary data and the satellite(s) is ready for use.

Each satellite has a 30-second data transmission that must be collected (hollow bar status) before that satellite may be used for navigation (solid bar status). Once a fix has been calculated, the GPS III Pilot will then update your position, track, and speed by selecting and using the best satellites in view. You can also access the GPS III Pilot's contrast feature from this page.

To adjust the screen contrast:

1. Press LEFT or RIGHT on the rocker keypad to adjust the level of contrast, and press ENTER to save the new contrast setting.

Sky View and Signal Strength Bars

The sky view and signal strength bars give you an indication of what satellites are visible to the receiver, whether or not they are being used to calculate a position fix, and the signal quality. The satellite sky view shows a bird's-eye view of the position of each available satellite relative to the unit's last known position. The outer circle represents the horizon (north up); the inner circle 45° above the horizon; and the center point directly overhead.

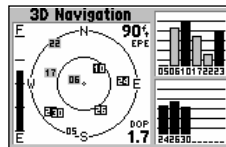

The Satellite Status Page shows where the satellites are and how strong the signal is from each one. A solid signal bar means the satellite is ready to use.

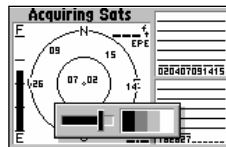

Use the LEFT/RIGHT keys on the rocker keypad to adjust the screen contrast. Press ENTER to save the setting.

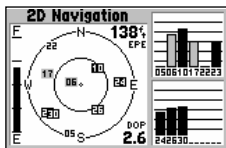

'2D Navigation' means the GPS III Pilot has determined a horizontal position (latitude/longitude), but is unable to determine altitude. Additional satellites may be needed.

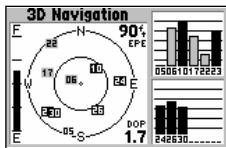

'3D Navigation' means the GPS III Pilot has determined a horizontal and vertical position (latitude, longitude and altitude). The receiver is ready for navigation.

You can use the sky view to help determine if any satellites are being blocked, and whether you have a current position fix (indicated by '2D Navigation' or '3D Navigation' in the status field). You can also set the sky view to a 'Track Up' configuration, causing the top of the sky view to align along your current track heading.

When the receiver is looking for a particular satellite, the corresponding signal strength bar will be blank and the sky view indicator will not be highlighted. Once the receiver has found the satellite, a hollow signal strength bar will appear, indicating that the satellite has been found and the receiver is collecting data from it. The satellite number on the sky view will appear highlighted. As soon as the GPS III Pilot has collected the necessary data to calculate a fix, the status field will indicate a 2D or 3D status. (For '2D', you may need to enter your altitude. See page 32.)

Receiver Status

Receiver status is indicated at the top left of the page. The status will be shown as one of the following conditions:

Searching— the GPS III Pilot is looking for any available satellites in view.

AutoLocate— the GPS III Pilot is initializing and collecting new almanac data. This process can take up to 5 minutes, depending on the satellites currently in view.

Acquiring— the receiver is collecting data from available satellites, but has not collected enough data to calculate a position fix.

2D Navigation— at least three satellites with good geometry have been locked onto and a 2-dimensional position fix (latitude and longitude) is being calculated. '2D Diff' will appear when you are receiving DGPS corrections in 2D mode.

3D Navigation— at least four satellites with good geometry have been locked onto, and your position is now being calculated in latitude, longitude and altitude. '3D Diff' will appear when you are receiving DGPS corrections in 3D mode.

Poor GPS Coverage— the receiver isn't tracking enough satellites for a 2D or 3D fix due to bad satellite geometry.

Not Usable— the receiver is unusable, possibly due to incorrect initialization or abnormal satellite conditions. Turn the unit off and back on to reset, and reinitialize the receiver if necessary.

Simulating Nav— the receiver is in simulator mode.

'Need to Select Initialization' Prompt

If no satellites are received for several minutes (or an insufficient number of satellites are received to determine a position fix) a message will appear, prompting you to initialize the receiver (see page 5). This allows you to specify a starting location from which to search for satellites, or to enable the AutoLocate feature, and is useful if you have traveled over 500 miles with the receiver off. (This message will automatically appear when you first use your GPS III Pilot. The prompt may also appear during normal use if the antenna is shaded or the unit is used indoors.)

Battery Level Indicator

The Satellite Status Page also features a battery level indicator, located to the left of the sky view, which displays the strength of the unit's batteries. The battery indicator will not appear if the receiver is operating on external power.



NOTE: The battery level indicator is calibrated for alkaline batteries. NiCad and lithium batteries will display the battery level differently due to voltage differences. To display battery level accurately select the appropriate type, as described on page 79. The GPS III Pilot features an internal 10-year lithium battery that will maintain the unit's memory when the receiver is not running off batteries or external power.

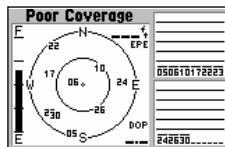

'Poor GPS Coverage' means the receiver isn't tracking enough satellites for a position fix. Check for obstructions, including metal objects, trees, buildings, etc.



This message appears if a position fix cannot be determined after several minutes. After acknowledging the message, select 'Use Map' or 'AutoLocate'.

REFERENCE

Satellite Status Page

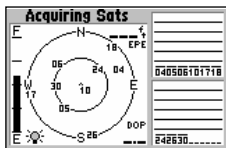

When screen backlighting is on, a bulb icon will appear in the lower-left corner of the Satellite Status Page.



The Satellite Status Page Options allow you to enable the built-in simulator, change the sky view orientation or initialize the receiver.

EPE and DOP

The Satellite Status Page also indicates the accuracy of the position fix, using Estimated Position Error (EPE) and Dilution of Precision (DOP) figures. DOP measures satellite geometry quality (i.e., number of satellites received and where they are relative to each other) on a scale from one to ten. The lowest numbers are the best accuracy and the highest numbers are the worst. EPE uses DOP and other factors to calculate a horizontal position error, in feet or meters.

Screen Backlighting

The GPS III Pilot's backlight feature illuminates the display and keypad for a user-defined interval (the default is 15 seconds) after the last key press. There are three levels of backlighting. When backlighting is on, a bulb icon will appear at the bottom left of the sky view. To adjust the duration of the screen backlighting, refer to the operation setup section (see p. 79).

To turn the screen backlighting on:

1. Cycle through the three levels of backlight by repeatedly pressing the red power key.

To turn the screen backlighting off:

1. Press the red power key. Whenever the GPS III Pilot's backlighting is off, the bulb icon disappears from the Satellite Status Page.

Satellite Status Page Options

Many features of the GPS III Pilot are menu driven. Each of the main pages has an options menu, allowing you to custom tailor the corresponding page to your preferences and/or select special features which specifically relate to that page.

To display the Satellite Status Page Options, press MENU (with the Satellite Status Page displayed).

The following Satellite Status Page options are available:

Start Simulator— allows you to activate the GPS III Pilot's built-in simulator mode. If 'Start Simulator' is selected, 'Stop Simulator' will appear as an option instead.

To activate (deactivate) simulator mode:

1. Highlight 'Start Simulator' (or 'Stop Simulator') and press ENTER.
2. Press ENTER again to confirm.

Track Up— changes the sky view display from 'North Up' orientation to align to current direction of travel (track). If 'Track Up' is selected, 'North Up' will appear as an option instead.

To change the sky view orientation:

1. Highlight 'Track Up' (or 'North Up') and press ENTER.

AutoLocate— forces the GPS III Pilot to search for any available satellite(s) to determine its position. This option may be used if you've relocated a long distance (>500 mi.) from the last location the GPS III Pilot was used.

To select AutoLocate, highlight 'AutoLocate' and press ENTER.

Initialize Position— allows you to designate your approximate position in order to speed up satellite acquisition. This option may be used in lieu of 'AutoLocate' (above) and typically provides a position fix quicker.

To initialize your starting position:

1. Highlight 'Initialize Position' and press ENTER.
2. Designate your approximate position on the map using the rocker keypad and press ENTER. (You may wish to use the IN/OUT zoom keys to adjust the level of detail displayed, as you determine your approximate position.)



'AutoLocate' forces the receiver to search for all satellites (twelve at a time) until enough satellites are found to determine a position.



'Initialize Position' is used to designate your approximate position directly on the map display. The receiver uses this information to determine which satellites should be in view.

REFERENCE

Position Page

| | | |
|---|--------------------------------|------------------|
| NW 330 345 N 015 030 | | |
| SPEED 0.0 ^m / _h | TRIP TIMER 01:48 | SUNRISE 05:57 |
| AVG SPEED 44.5 ^m / _h | TRIP ODOM 80.7 ^m | SUNSET 20:48 |
| N 38°51.339' | | 16:06:58: |
| W094°47.956' | | 01-JUL-97 |

The Position Page shows you where you are, what direction you're heading and how fast you're going.

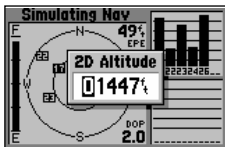

With 2D coverage, you will need to enter your approximate altitude. Without an approximate altitude, your position error can be substantial.

The second page in the GPS III Pilot's main page sequence is the Position Page. This page shows you where you are, what direction you're heading, and how fast you're going, and it's most useful when you are traveling without an active destination waypoint. The graphic heading display at the top of the page indicates the direction you're heading, or track, only while you're moving.

Directly below this display are the speed, average speed, trip timer, trip odometer and sunrise/sunset fields (default). The sunrise/sunset times indicated are for your present position. These times, and the current time display in the lower right-hand corner, can be displayed in local time or UTC (zulu) time. The lower left-hand corner of the page shows your current latitude and longitude in degrees and minutes (default). Units of measure and the position readout are selectable from the Main Menu, as outlined on page 77. Average speed, max speed, trip odometer and timers can each be reset from the Main Menu, as described on page 75.

2D Altitude Entry

When the GPS III Pilot is acquiring satellites or navigating in the 2D mode, the last known altitude will be used to compute your position. If the altitude shown is off by several hundred feet, you can manually enter your altitude for greater accuracy. In cases where the GPS III Pilot has only 2D coverage, entering your approximate altitude will enable the receiver to more accurately determine a position fix.

To enter an altitude:

1. Press PAGE (or QUIT) until the Satellite Status Page appears, then press MENU to view the available options.
2. Highlight 'Set 2D Altitude' and press ENTER.
3. Enter your approximate altitude using the rocker keypad, and press ENTER.

Position Page Options

Many features of the GPS III Pilot are menu driven. Each of the main pages has an options menu, allowing you to custom tailor the corresponding page to your preferences and/or select special features which specifically relate to that page.

To display the Position Page Options, press MENU (with the Position Page displayed).

The following options are available:

Average Position— allows you to average position samples over time and save the averaged result as a waypoint. Averaging reduces the effects of selective availability on position error and results in a more accurate position reading.

To average position samples and save the result as a waypoint:

1. Highlight 'Average Position' and press ENTER. The Average Position Page will appear. Observe the 'Estimated Accuracy' and 'Measurement Time' fields.
2. When the 'Estimated Accuracy' and/or 'Measurement Time' figures reach the desired value(s), highlight 'Save' and press ENTER. (To cancel the averaging function, highlight 'Discard' and press ENTER.)
3. The Waypoint Definition Page appears with a three-digit number assigned as a name for the new waypoint. To save the waypoint with this name, highlight 'Done' and press ENTER. **Or,**
4. To change the waypoint name, highlight the waypoint name field and press ENTER. Use the rocker keypad to enter a new name for this waypoint and press ENTER when finished. Highlight 'Done' and press ENTER to save the waypoint.



The Position Page Options allow you to average position samples and save the result as a waypoint, change data fields or restore factory defaults.

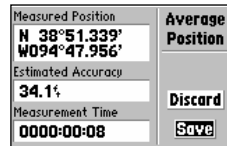

When averaging positions to create a waypoint, observe the 'Estimated Accuracy' and 'Measurement Time' figures. When they reach the desired value(s), highlight 'Save' and press ENTER.

REFERENCE

Position Page Options

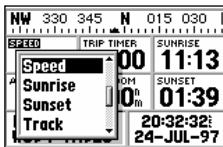

'Change Fields' allows you to custom tailor the information that appears on the Position Page. Select the desired data type from the list.



'Restore Defaults' will override any data field changes you've made to the Position Page, reverting back to the factory default settings.

Change fields— allows you to choose the data displayed on the six user-selectable data fields. Available data types are: Altitude, Average (Avg) Speed, Battery (Bat) Timer, Max Speed, Odometer, Speed, Sunrise (at present position), Sunset (at present position), Track, Trip Odometer, Trip Timer, User Timer and Voltage. See page 98 for descriptions of navigation terms.

To change a data field:

1. Highlight 'Change Fields' and press ENTER.
2. Highlight the data field you wish to change (using the rocker keypad) and press ENTER.
3. Select the type of data you want to appear on this field and press ENTER.

Restore Defaults— resets all data fields to the factory default settings.

To restore the factory default settings, highlight 'Restore Defaults' and press ENTER.

The GPS III Pilot features a powerful real-time moving map that can do much more than just plot your course and route. The Map Page also displays a digital chart, including airspace boundaries, airports, nav aids, lakes, rivers, coastlines and highways. An on-screen cursor lets you pan ahead to other map areas, determine the distance and bearing to any map position, and perform various waypoint and route functions. The GPS III Pilot also features dedicated zoom keys for instant zooming (see p. 2). The map portion of the page displays your present position using an aircraft icon, with your track and/or route displayed as small points on the screen (an electronic bread crumb trail, if you will). You may select which features are shown via the Map Page Options (see pp. 37).

The data window beside (or above when display is vertical) the map displays the time and distance to next waypoint, plus your current speed (all defaults). A bearing pointer lets you know if you're heading toward your destination. If the pointer points straight ahead, you're heading directly to it. If the pointer points any direction other than up, turn toward the arrow until it points up—then continue in that direction. Each data field may be configured to display any one of twenty-eight data options.

Zooming and Panning

There are three main functions you can perform from the Map Page: zooming, panning, and pointing. The map display has 23 scales (from 120 feet to 500 miles, or 30 meters to 800 km) which are selected by pressing the IN and OUT zoom keys. The current map scale is indicated in the bottom left corner of the map display.

To change the map scale:

1. Press zoom IN to see a smaller area with more detail.
2. Press zoom OUT to see a larger area with less detail.



The Map Page displays a digital chart, including airspace boundaries, airports, nav aids, rivers, lakes and highways.

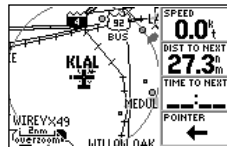

Zoom IN to see more detail for a smaller area. Zoom OUT to see a larger area.



Use the rocker keypad to pan away from your present position. Place the pointer over an airport or navaid and press ENTER to see more information.



By placing the panning pointer over an on-screen waypoint and pressing GOTO/ NRST, you won't have to manually enter the identifier for the waypoint.

Another function on the Map Page is the pan function, which allows you to move the map with the keypad in order to view areas beyond the current map.

To activate the pan function:

1. Use the rocker keypad to move the map in any direction, including diagonally.

As you begin to pan on the map, a pointer appears. This map pointer will serve as a target marker for the map. When the pointer is placed on an object, the name of that object will be highlighted. (If the name wasn't originally displayed it will appear when the pointer is placed on the object.) This feature applies to airports, navaids, user-created waypoints, roads, lakes, rivers—pretty much everything displayed except route lines and track log data.

When a waypoint name is highlighted, you can review information about the waypoint, list waypoint options, or execute a GOTO right from the Map Page.

To select an on-screen airport or navaid with the panning pointer:

1. Use the rocker keypad to highlight the desired item.
2. To view additional database information about the selected item, press ENTER/MARK.
3. To exit the information pages, press QUIT.

To GOTO a highlighted waypoint:

1. With the waypoint highlighted, press GOTO/NRST, followed by ENTER.

The GOTO function can be used anywhere on the map. If nothing currently exists at the map pointer position, a new waypoint (called 'MAP') will be created at the pointer's location before the GOTO is initiated.

To cancel the pan function and re-center the map on your position:

1. Press the QUIT key.

Many features of the GPS III Pilot are menu driven. Each of the main pages has an options menu, allowing you to custom tailor the corresponding page to your preferences and/or select special features which specifically relate to that page.

To display the Map Page Options, press MENU (with the Map Page displayed).

The following options are available:

Data Fields Off— allows you to select between a full-screen map display or the default map display with data window. If the data fields are off, 'Data Fields On' will appear as an option instead.

To turn the data fields off (or on), highlight 'Data Fields Off' (or 'Data Fields On') and press ENTER.

Change fields— allows you to choose the data displayed on four user-selectable data fields. There are twenty-eight available data types, including Average (AVG) Speed, Bearing, Distance, ETA to Destination (DEST), Speed, Time to Destination, Track and a Trip Odometer. See page 98 for descriptions of navigation terms.

To change a data field:

1. Highlight 'Change Fields' and press ENTER.
2. Highlight the data field you wish to change and press ENTER.
3. Select the type of data you want to appear on this field and press ENTER.

Measure Dist— allows you to measure the bearing and distance between any two points on the map display.

To measure bearing and distance between two points:

1. Highlight 'Measure Dist' and press ENTER. An on-screen pointer will appear on the map display at your present position.



A full-screen map, without the data fields, is available by selecting the 'Data Fields Off' option.

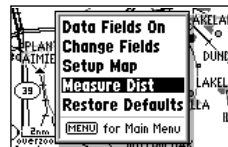

When using the 'Measure Dist' option, an arrow appears with an 'Enter Reference' prompt. Point to the initial reference point and press ENTER.

REFERENCE

Map Page Options

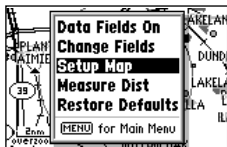

'Setup Map' allows you to change map orientation, background map detail, on-screen Jeppesen data, text size, etc.

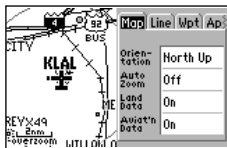

The map settings are organized by a series of 'file tabs'. Use the rocker keypad to select the desired tab, and to select the desired setting(s).

2. Move the pointer to the desired reference point (the point you want to measure from) and press ENTER.
3. Move the pointer to the point you want to measure to. The bearing and distance from the reference point will be displayed at the bottom left of the data window.

Restore Defaults— resets all data fields to the factory default settings.

To restore the factory default settings, highlight 'Restore Defaults' and press ENTER.

Setup Map— allows you to configure the map display to your preferences, including map orientation, land data enable/disable, Jeppesen data enable/disable, automatic zoom, airspace boundaries, and text size. The map setup option uses a 'file tab' feature, making it easier to organize the various settings and easier for you to use. The following table lists the file tabs and available settings:

| | |
|-------|--|
| Map | Orientation, AutoZoom, Land Data, Aviation Data |
| Line | Track Log, Active Route Lines, Lat/Long Grid Lines |
| Wpt | User Waypoints, Waypoint Text, Active Route Wpts |
| Apt | Large/Medium/Small Airports and Text |
| Nav | VORs, NDBs, Intersections and Text |
| Ctrl | Controlled Airspace: Class B/C/D |
| SUA | Special-Use Airspace: Restricted, MOA, Other |
| City | Large/Medium/Small Cities and Text |
| Road | Freeway, Nat'l Highway, Local Highway, Local Road |
| Other | States/Prov, Rivers/Lakes, Metro Areas, Railroads |

NOTE: Large airports are those with a runway longer than 8000'. Medium airports are those with a runway longer than 5000' or with a control tower. Large cities are those with approximate populations greater than 100,000 and medium cities are those with approximate populations over 5,000.

To change a map setup feature:

1. Highlight 'Map Setup' and press ENTER.
2. To change map orientation, select the 'Map' tab (if not already selected) and press ENTER. Highlight the 'Orientation' field and press ENTER. Select 'North Up' to fix the top of the map display to a north heading. Select 'Track Up' to adjust the top of the map display to your current track heading. Select 'DTK Up' to fix the top of the map display to your desired course. Press ENTER to accept the selected option.
3. To enable/disable automatic zoom, select the 'Map' tab (if not already selected), highlight the 'Auto Zoom' field and press ENTER. Select 'On' or 'Off' to enable or disable automatic zoom. Press ENTER to accept the selected option. The automatic zoom feature will automatically adjust the map scale from 80 nm through each lower scale, stopping at 800 ft as you approach your destination waypoint.
4. To enable/disable all land data or aviation data, select the 'Map' tab (if not already selected) and press ENTER. Highlight the appropriate field and press ENTER. Select 'On' or 'Off' to enable or disable all land data. Press ENTER to accept selected option.
5. For airports, nav aids, active route waypoints, user waypoints, state/provincial boundaries, rivers/lakes and cities: select the appropriate tab (per the chart on page 38) and press ENTER. Highlight the zoom field for the desired feature and press ENTER. Select the maximum scale at which the feature should appear on screen, or 'Off' to never display, and press ENTER. Highlight the text field for the desired feature and press ENTER. Select the text size for the desired feature, or 'None' to disable text, and press ENTER.
6. For airspace boundaries, highways, roads, railroad lines, metro areas, track log data, active route lines and lat/long grid: select the appropriate tab (per the chart on page 38) and press ENTER. Highlight the zoom field for the desired feature and press ENTER. Select the maximum scale at which the feature should appear on screen, or select 'Off' to never display the feature. Press ENTER to accept the settings.

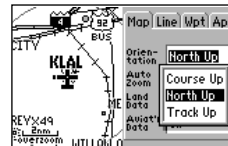

Select the 'North Up' option to keep the top of the map display fixed on North. "Track Up" will cause the map to rotate so the top of the map is the direction you're heading.

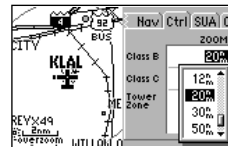

The 'Zoom' setting allows you to define the maximum scale at which the feature will appear. Once selected, that feature will appear at the selected scale and all lower scale settings.

REFERENCE

HSI Page



This example shows the aircraft heading parallel to the desired course, with the aircraft right of course more than 0.5 nm.



When off course beyond the limits of the CDI scale, the D-bar will appear in gray and stay at the edge of the scale (until your off course error is less than the limits of the scale).

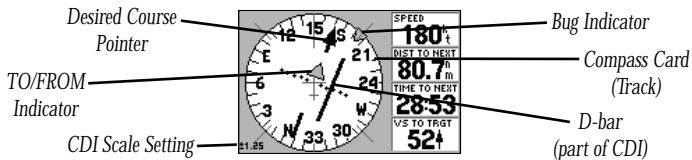

The primary navigation page, the HSI Page, also provides graphic steering guidance to your destination. The graphic HSI depicts the desired course to the destination waypoint (or the next waypoint in a route), current track, off course error and a TO/FROM indication. The rotating compass card indicates your current track, at the top of the page. The desired course pointer and CDI indicate the desired course and whether or not you're on the desired course. A bug indicator provides course to steer (CTS) information, guiding you back to the desired course should you stray off course.

The CDI is indicated by a course deviation scale (across the center of the HSI) and a moving D-bar (course deviation bar). If you move off course, the D-bar will indicate how far off course you are, based upon its placement along the course deviation scale. To get back on course and center the D-bar, simply steer toward the D-bar. The CDI scale setting is adjustable for 0.25, 1.25 or 5.0 (nautical mile/ statute mile/kilometer). The default setting is 1.25, which represents the distance from the center of the CDI to full left or right limits.

To change the CDI scale, use the IN/OUT zoom keys.

As you reach your destination, a TO/FROM indicator at the center of the HSI will indicate waypoint passage. Along the right-hand side of the page (top, when display is vertical) are four user-selectable data fields that display current speed, distance and time to next waypoint, and vertical speed to target (a vertical navigation function, described on page 43). These data fields may be configured to display different data.

Many features of the GPS III Pilot are menu driven. Each of the main pages has an options menu, allowing you to custom tailor the corresponding page to your preferences and/or select special features which specifically relate to that page.

To display the HSI Page Options, press MENU (with the HSI Page displayed).

The following options are available:

Set OBS and Hold— allows you to manually define the course to your destination waypoint. Once selected, the GPS III Pilot will use the OBS course setting for steering guidance with the CDI and desired course pointer.



NOTE: When using the GPS III Pilot's route features, 'Set OBS and Hold' will prevent the unit from automatically sequencing to the next route waypoint. To maintain the OBS course and retain automatic sequencing, you must also select the 'Release Hold' option, described on the following page.

To manually set a course to the destination waypoint:

1. Highlight 'Set OBS and Hold' and press ENTER. An OBS data field will appear on the HSI display.
2. Select the desired OBS course using the LEFT/RIGHT keys on the rocker keypad and press ENTER. The D-bar on the CDI and the desired course pointer will now provide steering guidance to the selected course.

To cancel the OBS course and reset a direct course to the waypoint, press GOTO and ENTER (or re-activate the route).



The 'Set OBS and Hold' option allows you to specify an inbound heading to a destination waypoint.



Use the rocker keypad to select the desired OBS heading. Note the heading at bottom center of HSI display (155° in this example).

REFERENCE

HSI Page Options

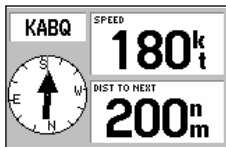

'Big Numbers' provides a smaller compass-type display, with a pointer indicating the bearing to your destination.

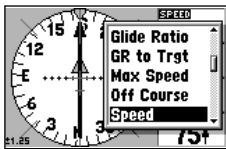

The 'Change Fields' option allows you to select from a list of available data types. Four different items may be displayed on the HSI Page's user-selectable data fields.

Release Hold— cancels the 'hold' feature enabled when the 'Set OBS and Hold' option was selected. This option returns the GPS III Pilot to automatic sequencing of waypoints along the active route. However, if an OBS course has been selected, that course setting will be retained until cancelled (as described on page 41) or until waypoint passage.

To release a waypoint hold and return to automatic sequencing of route waypoints, highlight 'Release Hold' and press ENTER.

Big Numbers— allows you to select a different page layout, with a smaller compass-type display and two user-selectable, large-character data fields. If 'Big Numbers' is selected, 'HSI' will appear as an option instead.

To toggle between HSI and Big Numbers page formats, highlight 'Big Numbers' (or 'HSI') and press ENTER.

Change Fields— allows you to choose the data displayed on four user-selectable data fields. There are twenty-nine available data types, including Average (AVG) Speed, Bearing, Distance, ETA at Destination (DEST), Speed, Time to Destination (DEST), Track, and a Trip Odometer. See page 98 for descriptions of data terms.

To change a data field:

1. Highlight 'Change Fields' and press ENTER.
2. Highlight the data field you wish to change and press ENTER.
3. Select the type of data you want to appear on this field and press ENTER.

Restore Defaults— resets all data fields to the factory default settings.

To restore the factory default settings, highlight 'Restore Defaults' and press ENTER.

REFERENCE

HSI Page Options

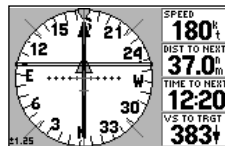

When using the vertical navigation features, a VNAV indicator (moving horizontal bar) will guide you as you descend to the target altitude.

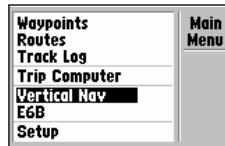

The Main Menu's 'Vertical Nav' option allows you to define the target altitude and where it should occur. The default settings are intended to guide you to pattern altitudes.

Capture VNAV Profile— is used to center/re-center the VNAV indicator (see illustration to the right) on the HSI display. To utilize this feature, a GOTO or route must be in use and a valid vertical navigation profile must be entered on the vertical navigation setup page (see the following page and page 75).

Cancel Capture— is used to return the VNAV indicator to the settings originally entered on the vertical navigation setup page (see the following page and page 75).

Vertical Navigation

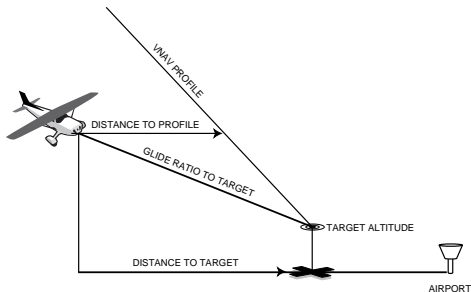

The GPS III Pilot's vertical navigation feature allows you to create a three-dimensional profile which guides you from your present position and altitude to a final (target) altitude at a specified location. Once the profile is defined, message alerts and additional data on the HSI Page will keep you informed of your progress.



NOTE: To use the vertical navigation feature, your speed must be greater than 35 knots and you must be navigating to a GOTO destination or using a route.

REFERENCE

Vertical Navigation

| Vertical Nav | | |
|-----------------|-----------|---------|
| Target Altitude | Above Wpt | |
| 1000' | | |
| By | Above Wpt | |
| 4.0% | MSL | |
| VNav Waypoint | Profile | Message |
| KABQ | 400+ | On |

Your target altitude can be defined as height 'Above Wpt' or 'MSL'. 'Above Wpt' only applies to airports. Use 'MSL' for all other waypoint types.

| Vertical Nav | | |
|-----------------|-----------|---------|
| Target Altitude | Above Wpt | |
| | | |
| By | Before | |
| KCOS | | |
| TAS | | |
| KABQ | | |
| VNav Waypoint | Profile | Message |
| KABQ | 400+ | On |

When using a route, vertical navigation can apply to any waypoint along the route by selecting it as the 'VNAV Waypoint'.

To create a vertical navigation profile:

1. Select the Main Menu by pressing MENU twice.
2. Select 'Vertical Nav' using the rocker keypad and press ENTER.
3. With the 'Target Altitude' field highlighted, press ENTER. Enter the desired target altitude and press ENTER.
4. With the altitude reference field (immediately to the right of 'Target Altitude') highlighted, press ENTER. Select 'Above Wpt' or 'MSL' (as desired) and press ENTER. 'Above Wpt' will use the altitude of a destination airport as stored in the internal Jeppesen database. 'MSL' lets you set a specific target altitude for any waypoint category: airport, VOR, NDB, intersection or user waypoint.
5. With the waypoint distance 'By' field highlighted, press ENTER. Enter an offset distance from the destination waypoint where the target altitude should be reached. If the target altitude occurs at the destination waypoint, enter a distance of zero. Press ENTER when finished.
6. With the offset direction field (immediately to the right of 'By') highlighted, press ENTER. Select 'Before' or 'After' and press ENTER. This setting designates whether the offset distance defines a point before you reach the destination waypoint or after you reach the destination waypoint.
7. When using a route, the 'VNAV Waypoint' field allows you to specify which route waypoint will be used for the vertical navigation profile. By default, the GPS III Pilot will select the last waypoint in the route. To select a different waypoint, highlight the 'VNAV Waypoint' field, press ENTER, select the desired waypoint and press ENTER.
8. The default profile utilizes a 400 foot-per-minute descent rate. To change the rate, highlight the 'Profile' field, press ENTER, enter a new rate and press ENTER again.
9. To enable/disable all vertical navigation messages, highlight the 'Message' field and press ENTER. Select 'On' or 'Off' (as desired) and press ENTER.

REFERENCE

Vertical Navigation

With the profile set, the HSI Page will guide you through the maneuver. Data fields on the HSI Page can be configured to indicate the time to beginning of maneuver, glide ratio and vertical speed to target. A VNAV indicator on the HSI display will guide you along the proper descent angle. Expect the following to occur when using the vertical navigation feature:

- As you approach the initial descent point, the time to vertical navigation ('Time to VNV') field indicates the time to reach the initial descent point.
- At one minute prior to the initial descent point, a message 'Approaching VNAV Profile' occurs. The time to vertical navigation ('Time to VNV') will sequence from indicating time to initial descent point to indicating time to reach target altitude. Finally, the descent angle will lock to prevent changes in speed from altering the profile.
- At 500 feet above the target altitude, an 'Approaching Target Altitude' message is provided. The time to vertical navigation ('Time to VNV') figure will go blank and the VNAV indicator will disappear from the HSI Page.



WARNING: GPS accuracy may be degraded by the U.S. Department of Defense-imposed Selective Availability (SA) program. With 'SA' on, GPS altitude may be in error by several hundred feet. Errors of this magnitude may result in fluctuations in the VNAV indicator on the HSI Page. The GPS III Pilot is a VFR navigation tool and should not be used to perform instrument approaches.



Within one minute of the initial descent point, an 'Approaching VNAV Profile' message will appear.



Once you are within 500 feet of the target altitude, the 'Approaching Target Altitude' message will appear and the VNAV indicator will be removed from the HSI display.

REFERENCE

Highway Page

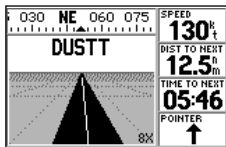

Your course is represented by the highway center line. Keep the center line in the middle of the display to stay on course.

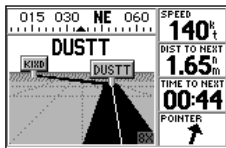

When using a route, the Highway Page will guide you to each waypoint along the route.

Whenever a destination waypoint(s) has been selected, the GPS III Pilot's Highway Page will guide you to your destination with digital readouts and a highway display. Along the right side of the page (top, when display is vertical) are four user-selectable data fields that display current speed, distance and time to next waypoint, and a bearing pointer (defaults). The bearing pointer always points to the destination waypoint (or the next waypoint when using a route) relative to the direction you are moving (track). If the bearing pointer points straight ahead, you are heading directly to your destination. If the bearing pointer points any direction other than up, turn toward the arrow until it points up—then continue in that direction.

The graphic heading compass at the top of the page indicates the direction you are moving (track). Directly below the heading compass, the highway display provides visual guidance to the destination waypoint and keeps you on your intended course line. Your course is represented by the center line down the middle of the graphic highway. As you head toward your destination, the highway perspective will move to indicate your progress to the waypoint and which direction you should steer to stay on course. If you are navigating a route, the highway display will show each route waypoint in sequence, with the route course indicated by a black highway. Nearby airports not in the route will also be displayed. Five available scale settings allow you to zoom in or out on the highway display for a smaller or larger view. The current scale setting, ranging from 1X to 16X, appears on the lower right corner of the highway display.

To zoom in or out on the highway display:

1. Press the IN zoom key to decrease the scale and show a smaller view area.
2. Press the OUT zoom key to increase the scale and show a larger view area.

Highway Page Options

Many features of the GPS III Pilot are menu driven. Each of the main pages has an options menu, allowing you to custom tailor the corresponding page to your preferences and/or select special features which specifically relate to that page.

To display the Highway Page Options, press MENU (with the Highway Page displayed).

The following options are available:

Sign Posts Off— removes the waypoint markers from the highway display. If 'Sign Posts Off' is selected, 'Sign Posts On' will appear as an option instead.

To remove (or display) waypoint markers on the highway, highlight 'Sign Posts Off' (or 'Sign Posts On') and press ENTER.

Change Fields— allows you to choose the data displayed on four user-selectable data fields. There are twenty-seven available data types, including Average (AVG) Speed, Bearing, Distance, ETA at Destination (DEST), Speed, Time to Destination (DEST), Track, a Trip Odometer and a bearing pointer. See page 98 for descriptions of navigation terms.

To change a data field:

1. Highlight 'Change Fields' and press ENTER.
2. Highlight the data field you wish to change and press ENTER.
3. Select the type of data you want to appear on this field and press ENTER.

Restore Defaults— resets all data fields to the factory default settings.

To restore the factory default settings, highlight 'Restore Defaults' and press ENTER.



The Highway Page Options let you configure the Highway Page to your preferences.

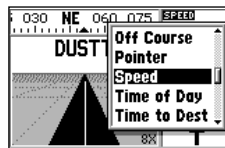

'Change Fields' allows you to choose the type of data to display on four user-selectable data fields. Select the desired type from the 'Change Fields' list.

REFERENCE

Waypoint Categories

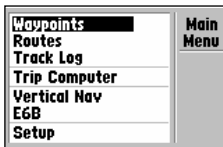

The Main Menu's 'Waypoints' option allows you to view database information for airports, runways, comm frequencies, VORs, NDBs, etc.

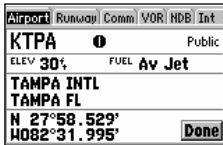

Select the desired waypoint category by selecting the corresponding 'file tab' at the top of the page.

Your GPS III Pilot uses a built-in Jeppesen database to provide position and facility information for thousands of airports, VORs, NDBs and intersections. Each facility in the database is stored as a waypoint, with its own latitude/longitude, identifier (up to six letters and/or numbers) and other pertinent information. Waypoint information is available from the 'Waypoints' selection under the Main Menu. Waypoint information is divided into categories (each represented by a 'file tab'), with different types of information available for each. The following table lists the file tabs and information available under each tab:

| | |
|-----------|---|
| Airport | Identifier, city/state, name, position, elevation, fuel |
| Runway | Length, width, orientation, surface, lighting, diagram |
| Comm | Frequencies for: ATIS, pre-taxi, clearance, ground, tower, unicom, multicom, approach, departure, arrival, class B, class C, TMA, CTA, TRSA |
| VOR | Identifier, city/state, facility name, position, freq., indication of co-located DME or TACAN |
| NDB | Identifier, city/state, facility name, position, freq. |
| Int | Intersection name, region/country, nearest VOR |
| User Wpt | Name, position, user comments, reference waypoint |
| User List | Name, symbol, total number of user waypts created |

To view waypoint information:

1. Press MENU twice to display the main menu.
2. Highlight 'Waypoints' using the rocker keypad and press ENTER. One of the waypoint information pages listed above will be displayed.
3. A series of tabs across the top of the page will indicate the other available pages. Select the desired page using the rocker keypad.

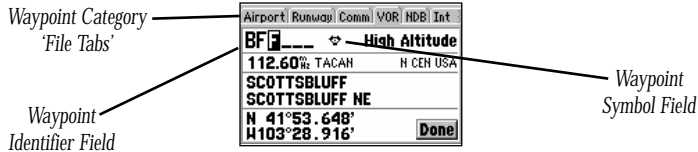

To select the desired waypoint, by identifier:

1. Highlight the waypoint identifier field using the rocker keypad and press ENTER.
2. Use the rocker keypad to enter the desired identifier—UP/DOWN to change each character and RIGHT to move to the next character.
3. As the identifier is entered, the GPS III Pilot will scroll through the database, displaying any waypoints with the same identifier letters you have entered to that point. When the desired waypoint is displayed, press ENTER.



NOTE: The GPS III Pilot uses International Civil Aviation Organization (ICAO) identifiers to designate airports. In the United States, the prefix letter for airports is 'K'. This applies to airport identifiers that are letters only. For example, 'LAX' becomes 'KLAX' and 'JFK' becomes 'KJFK'. Airport identifiers that use numbers, such as 'H34' or '7M5', do not use the 'K' prefix.

Some waypoints in the database may have the same identifier. When you have entered a waypoint name that is not unique, a Duplicate Waypoint Page appears, prompting you to select the desired waypoint. A list showing each duplicate by waypoint category and region/country makes it easy to identify the correct one.

To select the desired waypoint from a list of duplicates, highlight the desired waypoint and press ENTER.

REFERENCE

Waypoint Information Pages

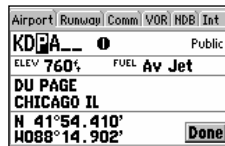

Waypoints are selected by identifier (or name). Enter the desired identifier in the waypoint identifier field, using the rocker keypad.

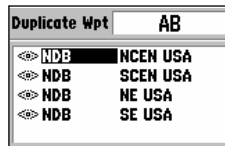

If more than one waypoint uses the same identifier, the Duplicate Waypoint Page allows you to choose the correct one.

REFERENCE

Waypoint Information Pages

| Airport | Runway | Comm | VOR | NDB | Int |
|---------------------|--------|---------------|-----|-----|-------------|
| PAMR | | | | | Public |
| ELEV 140' | FUEL | Av Jet | | | |
| MERRILL | | | | | |
| ANCHORAGE AK | | | | | |
| N 61°12.867' | | | | | |
| W149°50.768' | | | | | Done |

Airports, VORs and NDBs can also be selected by the facility's name or the city where the facility is located.

| Airport | Runway | Comm | VOR | NDB | Int |
|-----------------------------|--------|---------------|-----|-----|-------------|
| KMKC | | | | | Public |
| ELEV 760' | FUEL | Av Jet | | | |
| KANSAS CITY DOWNTOWN | | | | | |
| KANSAS CITY MO | | | | | |
| N 39°07.390' | | | | | |
| W094°35.568' | | | | | Done |

The Airport Information Page includes airport position coordinates, field elevation and available fuels. This page will also indicate if the facility is public use or military.

The 'Airport', 'VOR' and 'NDB' information pages also allow you to retrieve the desired waypoint by entering the facility name or the city name.

To select the desired waypoint, by facility or city name:

1. Use the rocker keypad to highlight the facility name or city name field. Press ENTER.
2. Use the rocker keypad to enter the desired name—UP/DOWN to change each character and RIGHT to move to the next character.
3. As the name is entered, the GPS III Pilot will scroll through the database, displaying any waypoints with the same letters you have entered to that point. In some instances there may be more than one waypoint with the desired name. (This often occurs when searching by city name.) To view all waypoints with the desired name, continue spelling the name with the rocker keypad. Once the name appears on-screen, continue to press UP/DOWN on the rocker keypad to view all entries for that name.
4. When the desired waypoint is displayed, press ENTER.

Airport Information Page

The Airport Information Page displays the identifier, facility name, city, position, elevation and available fuels for the selected airport. Position and elevation information will be in the format specified on the Setup pages (see page 77). Available fuel can be any of the following types:

- AV — AVGAS: 80-87 octane, 100LL, 100-130 octane
- JET — Jet A, Jet A-1, Jet A+
- MO — MOGAS: 87 octane unleaded

Runway Information Page

The Runway Information Page displays the identifier, designations, length, width, surface type and lighting information for the selected airport. This page also provides a graphic diagram of the runways and a map of the surrounding area. The surface type information can be any one of: hard, turf, sealed, gravel, dirt, soft, unknown, or water. The lighting information will indicate one of five lighting schemes: part time, full time, pilot controlled (with frequency), no lighting or unknown.

If the selected airport has more than one runway, additional runway data can be viewed by selecting another runway from the runway designation field.

To view additional runway data:

1. Highlight the runway designation field and press ENTER. A list of the available runways will appear.
2. Select the desired runway using the rocker keypad and press ENTER.

Communication Information Page

The Communication Information Page displays the identifier and radio frequencies for the selected airport, along with any usage restrictions which may apply to a given frequency. When a frequency type is followed by an '*', that frequency will have usage restrictions, typically based upon sector and/or altitude.

To view usage restrictions for a communication frequency:

1. Highlight the desired frequency (one with a type that's followed by '*') and press ENTER. An information page will appear with additional data about the frequency.
2. Press QUIT to return to the Communication Information Page.



The Runway Information Page allows you to view the runways and the surrounding area. Select the runway designation field to view data for additional runways.

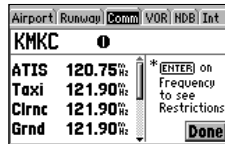

The Airport Communication Information Page shows the radio frequencies for the selected airport. Any frequencies with restrictions are denoted by an asterisk (*) after the frequency type.

REFERENCE

Waypoint Information Pages

| Airport | Runway | Comm | VOR | NDB | Int |
|----------------------|--------|----------|-----|-----|----------------------|
| BKA | | | | | High Altitude |
| 113.80 | | WX TACAN | | | ALASKA |
| BIORKA ISLAND | | | | | |
| SITKA AK | | | | | |
| N 56°51.564' | | | | | |
| W 135°33.083' | | | | | Done |

The VOR Information Page provides complete information about the selected VOR, including facility name, city, frequency and designation for co-located DME or TACAN.

| Airport | Runway | Comm | VOR | NDB | Int |
|----------------------|--------|------|-----|-----|-------------|
| DL | | | | | |
| 379.00 | | WX | | | N CEN USA |
| PYKLA | | | | | |
| DULUTH MN | | | | | |
| N 46°50.742' | | | | | |
| W 092°21.301' | | | | | Done |

Both the NDB and VOR Information Pages provide 'WX' indications if the selected facility broadcasts weather information.

VOR Information Page

The VOR Information Page displays the identifier, facility name, city name, region/country, position and frequency for the selected VOR. The facility type (terminal, low altitude or high altitude) is also indicated. If DME or TACAN equipment is co-located at the site, it will be indicated next to the transmitting frequency. Likewise, if the facility broadcasts weather information, 'WX' will appear next to the transmitting frequency. Position information will be in the format specified on the Setup pages (see page 86).

NDB Information Page

The NDB Information Page displays the identifier, facility name, city name, region/country, position and frequency for the selected NDB. If the facility broadcasts weather information, it will be indicated by a 'WX' appearing next to the transmitting frequency.

Intersection Information Page

The Intersection Information Page displays the identifier, position, region and country for the selected intersection. The page also shows the bearing and distance to the nearest VOR facility.



NOTE: The VOR displayed is simply the nearest facility and may not be the facility used to define the intersection.

REFERENCE

Nearest Airports, etc.

In addition to being used to define a GOTO destination, the GPS III Pilot's GOTO/NRST key can also be used to view detailed information on the nine nearest airports, VORs, NDBs, intersections and user waypoints within 200 miles of your present position. Information regarding the five nearest FSS (flight service station) and center (ARTCC) points of communication, along with associated frequency(s) is available from the Nearest Page, as well. When an airspace alert is provided, the Nearest Page will even provide additional detail about the airspace. Nearest information is selected by choosing the appropriate 'file tab', based upon the desired information. The following table lists the file tabs and information available under each tab:

| | |
|-----------|--|
| Airports | nine nearest with identifier, bearing to and distance |
| VORs | nine nearest with identifier, bearing to and distance |
| NDBs | nine nearest with identifier, bearing to and distance |
| Ints | nine nearest with identifier, bearing to and distance |
| User Wpts | nine nearest with name, bearing to and distance |
| ARTCC | five nearest with bearing to, distance and frequency(s) |
| FSS | five nearest with bearing to, distance, freq(s) and VOR (for duplex operations) |
| Airspaces | up to three (depending on number of alerts provided) with type, controlling agency, frequency(s) and floor/ceiling altitude limits |

To view the Nearest Page:

1. Press and hold the GOTO/NRST key.
2. Select the desired information by highlighting the appropriate tab from the chart above.

| Airports | VORs | NDBs | Ints | Use |
|----------|---------|----------|------|-----|
| Waypoint | Bearing | Distance | | |
| KBFI | 341° | 0.00 | | |
| KRNT | 102° | 4.18 | | |
| KSEA | 164° | 4.88 | | |
| 2S1 | 219° | 8.33 | | |
| S50 | 146° | 12.5 | | |

The Nearest Page organizes the nearest airports, nav aids, FSS, center and airspace information by 'file tab' headings. Select the appropriate tab for the desired information.

| CC | FSS | Airspaces |
|------------------------------|-----|-----------|
| JOHNSON CO EXECUTIVE | | |
| Inside | | |
| NEW CENTURY AIRCENTER | | |
| 01:17 ahead, < 2 nm away | | |

Nearest airspace information is available on the Nearest Page, once an airspace alert has been provided.

REFERENCE

Nearest Airports, etc.

| Control Tower | |
|-----------------------------|----------------------|
| JOHNSON CO EXECUTIVE | |
| Controlling Agency | |
| TOWER | |
| Status | Vertical Boundaries |
| 00:13 ahead, < 2 nm away | See Chart Surface |
| Frequencies | Done |

To view the database information for a nearby airspace, highlight the airspace on the Nearest Page and press ENTER.

| Airports | VORs | NDBs | Ints | Use |
|----------|---------|----------|------|-----|
| Waypoint | Bearing | Distance | | |
| KBFI | 341° | 0.00 | | |
| KRNT | 102° | 4.18 | | |
| KSEA | 164° | 4.88 | | |
| 2S1 | 219° | 8.33 | | |
| S50 | 146° | 12.5 | | |

To immediately set a GOTO course for a nearest airport, highlight the desired airport on the Nearest Page, press GOTO/NRST and then ENTER.

As mentioned earlier, additional information is stored in the GPS III Pilot's Jeppesen database. This information may be retrieved using the 'Waypoints' option on the Main Menu, but it is also available from the Nearest Page.

To view additional information for a nearest airport, VOR, NDB, intersection, user waypoint or airspace:

1. Highlight the desired item (from the Nearest Page) using the rocker keypad.
2. Press ENTER to view the database information for the selected item.
3. Press QUIT to return to the Nearest Page.

You can easily set a GOTO course directly to a nearest waypoint. In an emergency, a few simple keystrokes can guide you to the closest point to set down. (See page 61 for more detail about the GPS III Pilot's GOTO features.)

To GOTO a nearest waypoint, highlight the desired waypoint from the Nearest Page, press GOTO/NRST and ENTER.

Airspace information also includes the frequency(s) of the controlling agency.

To view controlling agency frequency(s) for a nearby airspace:

1. With the information page displayed for the desired airspace, highlight the 'Frequencies' field and press ENTER.

The Nearest Page displays one FSS or ARTCC at a time. Information for up to five remote communication outlets is available.

To view additional nearest FSS or ARTCC points of communication:

1. Highlight the 'Station' field and press ENTER.
2. Select the desired listing, numbered 1 through 5, and press ENTER.

In addition to the built-in database, the GPS III Pilot also stores up to 500 user-defined waypoints, with a selectable symbol and comment available for each waypoint. User-defined waypoints can be created using four methods:

Mark Present Position— your present position can be captured and saved as a user waypoint using the ENTER/MARK key (press & hold).

On Map— a new user waypoint position can be created directly on the map display using the panning pointer and ENTER/MARK key (press momentarily).

Text Entry— user waypoints can be created by entering position coordinates manually (from a chart, etc.) or by referencing bearing and distance from a previously stored waypoint (or present position).

Average Position— position samples can be averaged over time and the result saved as a user waypoint. Averaging reduces the effects of selective availability and improves the accuracy of the position reading. (See page 33 for more info.)

Marking Present Position

The GPS III Pilot's "mark" feature lets you quickly capture your present position in order to create a new user waypoint. You must be locked onto satellites, with a valid position fix, to mark your present position.

To mark your present position:

1. Press and hold the ENTER/MARK key. The New Waypoint Page is automatically displayed.
2. To change the waypoint name (a three-digit number is automatically assigned), highlight the waypoint name field and press ENTER. Use the rocker keypad to enter the new waypoint name and press ENTER when finished.
3. To save the waypoint in memory, highlight 'Done' and press ENTER.

| New Waypoint | |
|--------------|-----------------|
| BEAC | ■ |
| CRTD | 03:26 01-JAN-05 |
| REF | |
| BRG | 000° DST 0.00m |
| N | 34°25.100' |
| W | 119°39.130' |
| Done | |

The ENTER/MARK key allows you to mark your current position as a user waypoint. You can give this waypoint any name you choose.

| Waypoint Symbol | |
|-----------------|-----------------|
| BE | Swimming Area |
| CR | Tall Tower |
| REF | Telephone |
| BRG | TracBack Point |
| N | Ultralight Area |
| W | |
| Done | |

You can also choose from a list of symbols used to identify the user waypoint on the map display.

REFERENCE

Creating User Waypoints

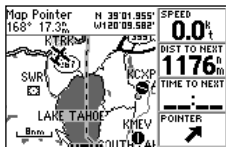

User waypoints can be created directly from the Map Page, by placing the panning pointer on the desired position and pressing ENTER.

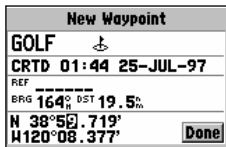

User waypoints can also be created by entering the position coordinates for the waypoint.

Marking User Waypoints on the Map Page

User waypoints can also be quickly created from the Map Page, which allows you to “point and shoot” at any map position to create a new waypoint.

To create a new user waypoint on the map:

1. Press the PAGE key repeatedly to select the Map Page.
2. Use the rocker keypad to move the pointer to the desired map position. You may also need to use the IN and OUT zoom keys, in conjunction with the rocker keypad, to speed up this process.
3. Press ENTER (momentarily) to capture the pointer's position and display the New Waypoint Page.
4. To change the waypoint name (a three-digit number is automatically assigned), highlight the waypoint name field and press ENTER. Use the rocker keypad to enter the new waypoint name and press ENTER when finished.
5. To save the waypoint in memory, highlight 'Done' and press ENTER.

Creating User Waypoints by Text Entry

User waypoints may be created by manually entering the position coordinates or by entering the bearing and distance from an existing waypoint (or present position).

To create a new user waypoint by manually entering its coordinates, or by bearing/distance from another position:

1. Press the MENU key twice to select the Main Menu.
2. Highlight 'Waypoints' and press ENTER.
3. Press MENU to display the Waypoint Options.
4. Highlight 'New Waypoint' and press ENTER. The Waypoint Definition Page appears.

Creating User Waypoints

- To enter a name for the new waypoint, highlight the waypoint name field and press ENTER. Use the rocker keypad to enter the waypoint name and press ENTER when finished.
- To enter position coordinates for the new waypoint, highlight the waypoint coordinates field and press ENTER. Use the rocker keypad to enter the position coordinates and press ENTER when finished. (For lat/lon coordinates, enter both the latitude and longitude information before pressing ENTER.) **Or**,
- To create the new waypoint by referencing another position, highlight the reference waypoint name field and press ENTER. Use the rocker keypad to enter the name of the reference waypoint and press ENTER. (If the reference waypoint name field is left blank, your present position will be used as the reference position.) Use the same procedure to enter the bearing (BRG) and distance (DST) from the reference waypoint to the new waypoint. (Remember to press ENTER once each data item is selected with the rocker keypad.)
- To save the new waypoint in memory, highlight 'Done' and press ENTER.

Waypoint Options

The Waypoint Options were displayed using the first three steps above. In addition to 'New Waypoint', there are additional options which vary depending on whether you are viewing Jeppesen database waypoints or user-defined waypoints:

Show Map— allows you to view the map area around the selected waypoint. While viewing the map display, you can also use the IN and OUT zoom keys to see additional detail.

Edit Waypoint ('User Wpt' tab only)— allows you to modify name, symbol, comment or position information for the selected waypoint.

Delete Waypoint ('User Wpt' and 'User List' tabs only)— allows you to delete the selected user waypoint from memory.



Select the 'Show Map' option to display the map area around a selected waypoint.

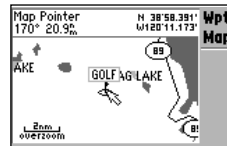

Once 'Show Map' is selected, use the panning pointer and/or the IN/OUT zoom keys to view the desired area and detail.

REFERENCE

Editing User Waypoints



User waypoints can be deleted individually, by common symbol or all at once. Select the desired 'Delete' option and press ENTER.

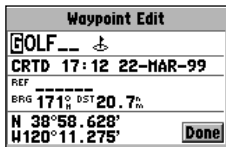

To rename a user waypoint, enter the new name directly over the old name and press ENTER.

Delete by Symbol ('User List' tab only)— allows you to select a user waypoint symbol and all waypoints with this corresponding symbol will be deleted from memory.

Delete All ('User List' tab only)— deletes all user waypoints currently stored in memory.

To delete a user waypoint (or waypoints):

1. Select the desired delete option from the list above and press ENTER.
2. If 'Delete by Symbol' is selected, select the desired symbol and press ENTER.

Editing User Waypoints

Once you have created and stored a user waypoint, it may be modified, renamed or deleted at any time through the Waypoint Edit Page. The Waypoint Edit Page for any stored user waypoint can be retrieved by selecting the desired waypoint on the map display, or from the waypoint information pages ('User Wpt' or 'User List' tabs).

To access the Waypoint Edit Page for a user waypoint:

1. Press the rocker keypad to highlight the desired user waypoint on the map display and press ENTER. **Or,**
2. Highlight 'Waypoints' from the Main Menu and press ENTER. Select the desired file tab. If 'User Wpt' is selected, press MENU, select 'Edit Waypoint' and press ENTER. If 'User List' is selected, highlight the desired waypoint and press ENTER.

From the Waypoint Edit Page, highlight the appropriate field to rename a waypoint, change its symbol, edit the comment or edit the position.

To rename the user waypoint:

1. Highlight the waypoint name field and press ENTER.
2. Use the rocker keypad to enter the new waypoint name and press ENTER.
3. If finished, highlight 'Done' and press ENTER.

To change the user waypoint's symbol:

1. Highlight the waypoint symbol field and press ENTER.
2. Use the rocker keypad to select the desired symbol and press ENTER. The selected symbol will be used to denote the waypoint position on the map display.

When a waypoint is created, the time and date of creation is automatically added as a waypoint comment. You can edit this information or create an entirely new comment, as needed.

To edit the user waypoint comment:

1. Highlight the waypoint comment field and press ENTER.
2. Use the rocker keypad to enter the desired comment and press ENTER.

To edit the user waypoint position:

1. Highlight the waypoint coordinates field to change the position coordinates, or highlight the reference waypoint name, bearing or distance fields to change the reference waypoint information. Press ENTER to begin editing.
2. Use the rocker keypad to enter the new information. Press ENTER to accept the new information.

A user waypoint's position may also be edited, graphically, using the map display.

To move a waypoint's position on the map display:

1. From the Waypoint Edit Page, press MENU to display the Waypoint Edit Options.
2. Use the rocker keypad to select 'Show Map' and press ENTER.
3. Press MENU to display an options window. Select 'Move Wpt' and press ENTER.
4. Use the rocker keypad to select the new location for the waypoint and press ENTER.

| Waypoint Edit | |
|----------------------|-----------------------|
| GOLF | ↕ |
| CRTD 17:12 22-MAR-99 | |
| REF ----- | |
| BRG 171° | DST 20.7 _m |
| N 38°58.628' | |
| W 120°11.275' | |
| Next | |

The default waypoint comment is the time and date the waypoint was created. You can enter your own comment using the rocker keypad.

| Waypoint Edit | |
|----------------------|-----------------------|
| GOLF | ↕ |
| CRTD 17:12 22-MAR-99 | |
| REF ----- | |
| BRG 171° | DST 20.7 _m |
| N 38°58.628' | |
| W 120°11.275' | |
| Next | |

Edit a user waypoint's position by entering the new position coordinates directly over the old position.

REFERENCE

Waypoint Options



'Show Map' allows you to view the area around the user waypoint's position.

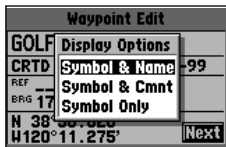

'Display Options' lets you determine what user waypoint information will appear on the map display.

The Waypoint Edit Page features additional options, besides the 'Show Map' option described in the previous steps. Waypoint Edit Options allow you to delete user waypoints, define how a user waypoint will appear on the map display or average the waypoint position to improve accuracy.

To display the Waypoint Edit Options, press MENU (with the Waypoint Edit Page displayed).

The following options are available:

Show Map— allows you to view the area surrounding the selected waypoint's position. While viewing the map display, you can also use the IN and OUT zoom keys to see additional detail.

Delete Waypoint— allows you to remove the selected user waypoint from memory.

To delete a waypoint:

1. Highlight 'Delete Waypoint' and press ENTER. A confirmation screen is displayed.
2. ENTER to delete (or QUIT to cancel).

Display Options— lets you select how the highlighted user waypoint will appear on the map display. Options are provided to show symbol & name, symbol & comment, or symbol only.

To change the display options for a user waypoint:

1. Highlight 'Display Options' and press ENTER.
2. Highlight the desired option and press ENTER.

Average Position— allows you to average position samples over time to improve the accuracy of the position reading and save the result as a user waypoint. (See page 33 for more information on averaging.)

The GPS III Pilot can navigate to a destination using any of three different methods:

GOTO— lets you select a waypoint as your destination and quickly plot a direct course from present position to that waypoint.

TracBack— allows you to retrace your path using the track log automatically stored in the receiver's memory. This eliminates the need to store waypoints along the way. (See page 64 for more information about TracBack.)

Routes— allows you to manually create a sequence of intermediate waypoints which lead you to your final destination. The GPS III Pilot will store up to 20 reversible routes, with up to 30 waypoints in each route.

GOTO Navigation

The easiest way to select your destination is by using the GOTO key. The GOTO key can be used by itself, after highlighting a waypoint name on a list, or after designating a position on the map display.

To GOTO a waypoint:

1. Press GOTO/NRST. The GOTO page shows a series of file tabs for 'Recent' waypoints, 'User' waypoints or 'Spell n Find'.
2. To GOTO a recently used waypoint, select the 'Recent' tab, highlight the desired waypoint and press ENTER.
3. To GOTO a user waypoint, select the 'User' tab, highlight the desired waypoint and press ENTER.
4. To enter the identifier of the destination waypoint, select the 'Spell n Find' tab and highlight the waypoint identifier (name) field. Press ENTER and use the rocker keypad to enter the identifier of the desired waypoint—UP/DOWN to change each character and RIGHT to move to the next character. Press ENTER to confirm the selection.



To GOTO a waypoint, press GOTO/NRST and highlight the waypoint identifier field at the top of the page.



Press ENTER and use the rocker keypad to enter the identifier of the destination waypoint. Press ENTER to begin navigation.

REFERENCE

GOTO

| Airports | VORs | NDBs | Ints | Use |
|----------|-------------------|----------|------|-----|
| Waypoint | Bearing | Distance | | |
| KTRK | 344° _N | 0.00 | | |
| 079 | 311° _N | 18.6 | | |
| KRNO | 042° _N | 20.3 | | |
| 004 | 096° _N | 20.3 | | |
| 205 | 092° _N | 22.3 | | |

By highlighting a waypoint identifier on a list and pressing GOTO/NRST, you won't have to manually enter the identifier for the waypoint.

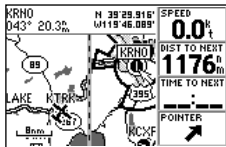

A GOTO can also be initiated from the map display by placing the panning pointer on the desired target waypoint.

To designate a GOTO waypoint from a list of waypoints:

1. Highlight the desired waypoint on the list and press GOTO/NRST. A confirmation page shows the selected destination waypoint.
2. Press ENTER to confirm the selected waypoint and begin navigating.

To GOTO an existing waypoint on the map display:

1. Use the rocker keypad to place the crosshair on the desired target waypoint.
2. Press GOTO/NRST, followed by ENTER, to begin navigating.

To GOTO any position on the map display:

1. Use the rocker keypad to place the crosshair on any position you wish to navigate to.
2. Press GOTO/NRST to create a waypoint, called 'MAP', at the crosshair position. Each time you perform this step, it will overwrite any previously created 'MAP' waypoint.
3. Press ENTER to begin navigating.

To select a GOTO waypoint by facility name or city (applicable to airports, VORs and NDBs only):

1. Press GOTO/NRST and select the 'Spell n Find' tab, as described on the previous page.
2. Highlight the facility name or city name field, as desired, and press ENTER.
3. Use the rocker keypad to enter the facility name/city. As you enter the first few characters, the GPS III Pilot's Spell n Find feature will scroll through the database, displaying any waypoints which match the letters you have entered. When searching by city name, there may be multiple waypoints for the same city. Continue scrolling with the UP/DOWN portion of the rocker keypad to scroll through these entries.
4. When the desired waypoint appears, press ENTER.

REFERENCE

GOTO Options

GOTO Options are also provided to initiate a TracBack route or to cancel the current GOTO destination.

To display the GOTO Options, press MENU (immediately after pressing GOTO/NRST).

The following options are available:

TracBack— allows you to retrace your path using the track log automatically stored in the receiver's memory. This eliminates the need to store waypoints along the way. (See page 64 for more information about TracBack.)

Cancel GOTO— cancels the current GOTO destination and resumes navigation of any previously selected route. If no route is currently in use; bearing, distance, etc. will remain blank until a destination waypoint is defined.

To cancel the current GOTO destination, highlight 'Cancel GOTO' and press ENTER.



'TracBack' allows you to retrace your path based upon an automatic track log recording.



To cancel a current GOTO destination, select 'Cancel GOTO' from the GOTO Options.

REFERENCE

TracBack

| Track Log | |
|-------------|----------------|
| Memory Used | Record Mode |
| 21% | Wrap |
| Clear Log | Interval |
| TracBack | Resolution |
| | Interval Value |
| | 82% |

Clear the old track log before you depart. This defines the starting point for a TracBack route.

| | |
|---------------|-----------|
| Waypoints | Main Menu |
| Routes | |
| Track Log | |
| Trip Computer | |
| Vertical Nav | |
| EGB | |
| Setup | |

'TracBack' can also be initiated from the Main Menu's 'Track Log' option.

The TracBack navigation feature allows you to retrace your path using the track log automatically stored in the receiver's memory. This eliminates the need to manually store waypoints along the way. A track log is an electronic breadcrumb trail showing the path you have travelled. Your GPS III Pilot can be set to automatically record track log points anytime the receiver is on and locked onto satellites (see page 74).

TracBack routes are created by reducing your track log into a route of up to 30 waypoints and activating the new route in reverse order along those waypoints. Once activated, a TracBack route will lead you back to the oldest track log point stored in memory, so it's a good idea to clear the existing track log at the beginning of your current trip (e.g., at your home airport) before you get started.

To clear the track log and define the starting point for a TracBack route:

1. Press MENU twice to display the Main Menu.
2. Highlight 'Track Log' and press ENTER.
3. Highlight 'Clear Log' and press ENTER.
4. Press ENTER to delete the track log data (or press QUIT to cancel).

To create and activate a TracBack route:

1. Enable track log recording and leave the GPS III Pilot on to automatically record track log positions while under way. Refer to page 74 for information on track log settings.
2. Press MENU twice to display the Main Menu.
3. Highlight 'Track Log' and press ENTER.
4. Highlight 'TracBack' and press ENTER to create/activate the TracBack route. (A message box will appear while the unit analyzes the data and creates the route.)

REFERENCE

TracBack Tips

Once a TracBack has been activated, the GPS III Pilot will take the track log currently stored in memory and divide it into route segments, called 'legs'. Up to 30 track log waypoints (labeled 'T###', e.g. 'T001') will be created to mark the most significant features of the track log in order to duplicate your path as closely as possible. To gain the most benefit from the TracBack feature, keep the following tips in mind:

- Always clear the track log at the point you want to return to (your home, your home airport, etc.)
- The 'Record Mode' on the Track Log Setup Page must be set to 'Wrap' or 'Fill'.
- There must be at least two track log points stored in memory to create a TracBack route.
- If there is not enough available memory to add more waypoints and create a TracBack route, you will be alerted with a 'waypoint memory full' message. The receiver will use the available waypoints to create a route with an emphasis on the track log closest to the destination. Also, existing track log waypoints that are not contained in any route will be erased to free more memory. The GPS III Pilot will create the new waypoints using the first available three-digit number.
- If the Track Log Setup Page's 'interval' field is set to 'Time', the route may not follow your exact path. (Keep the 'interval' field set to 'Resolution' for best results.)
- If the receiver is turned off or satellite coverage is lost during your trip, TracBack will draw a straight line between any point where coverage was lost and where it resumed.
- If there are frequent changes in direction and distance in your track log, 30 waypoints may not accurately depict your exact path. The receiver will then assign the 30 waypoints to the most significant points of your track log, and simplify segments with fewer changes in direction.

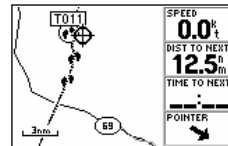

A TracBack route contains a series of waypoints labeled 'T###' that approximate your previous route of travel.



'Wrap' will overwrite the old track log data in memory, once all memory has been used.

REFERENCE

Routes

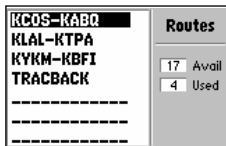

To display the Route List, showing all routes stored in memory, select 'Routes' from the Main Menu.



Select 'New Route' from the Route Options and enter the identifiers for the route waypoints in the sequence you wish to follow them.

Route navigation allows you to manually create a sequence of intermediate waypoints which lead you to your final destination. The GPS III Pilot will store up to 20 reversible routes, with up to 30 waypoints in each route. Routes can be created and modified by text entry—using the rocker keypad to enter waypoint names. All of the GPS III Pilot's route functions are accessed through a 'Routes' option on the Main Menu.

To create a new route:

1. Press MENU twice to display the Main Menu.
2. Highlight 'Routes' and press ENTER. The Route List is displayed, showing all routes stored in memory.
3. Press MENU to display the Route Options.
4. Highlight 'New Route' and press ENTER. The GPS III Pilot creates a route called 'Empty-XX'. (The name changes as you add waypoints to the route, so make note of the route name for future reference.)
5. Highlight the first waypoint name field and press ENTER to begin entering the name of an existing waypoint in memory.
6. Use the rocker keypad to enter the name of the route waypoint and press ENTER.
7. Highlight the next waypoint name field, press ENTER and repeat step 6 until all route waypoints have been added to the route.

Route List

The GPS III Pilot's Route List displays all the routes currently stored in memory, along with a descriptive name for each route. Once a route has been created, it can be activated and used for navigation from the Route List. A route may be followed in the same sequence as it was originally created, or you can invert the route and navigate from the end waypoint back to the beginning waypoint.

To activate a route:

1. Press MENU twice to display the Main Menu.
2. Highlight 'Routes' and press ENTER. The Route List is displayed, showing all routes stored in memory.
3. Highlight the desired route and press MENU to display the Route Options.
4. Highlight 'Activate' to navigate the route in sequence, and press ENTER.

The Route List also allows you to enter your own 13-character name for any listed route. By default the name includes the first and last waypoints in the route.

To enter a custom route name:

1. Follow steps 1 and 2 above to display the Route List.
2. Highlight the desired route and press ENTER to display the Route Edit Page.
3. Highlight the route name field (top line) and press ENTER to begin editing.
4. Use the rocker keypad to enter the desired name and press ENTER when finished.

When a route is highlighted on the Route List, additional functions are available from the Route Options.

To display the Route Options, press MENU (with the Route List displayed).

The following Route Options are available:

New Route— allows you to create a new route, as described on page 66.

Activate— allows you to navigate the route in the same sequence it was originally created, as described above.



Activating a route tells the GPS III Pilot you wish to use this route for navigation guidance.

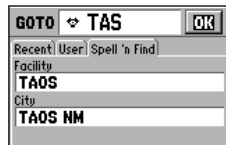

Selecting a GOTO destination along the current route will take you directly to that waypoint, then continue with the remainder of the route.

REFERENCE

Route Options



'Copy' allows you to make a duplicate of a route before making editing changes.



'Delete' will remove the route from memory, but not the waypoints contained in the route.

Invert— allows you to reverse the order of waypoints in the route.

Copy— allows you to copy the selected route to a new route. The copy function can be used to save a TracBack route for future use. The copy function is also useful for duplicating an existing route before making changes.

To copy a route:

1. Highlight 'Copy' and press ENTER.
2. The Route Plan Page will appear for the duplicate route and the name for the new route will be first and last waypoints in the route. If this name is identical to the original route name (or any other saved route), then a number will be added to the end of the name to create a unique name.

Delete Route— allows you to remove the selected route from memory. The waypoints contained in the route will still appear in memory, but not as part of the route.

To delete a route from memory:

1. Highlight 'Delete Route' and press ENTER. A confirmation page will appear.
2. Press ENTER to delete the route (or QUIT to cancel).

Delete All— allows you to remove all routes from memory. The waypoints contained in all stored routes will remain in memory, but not as part of any route.

To delete all routes from memory:

1. Highlight 'Delete All' and press ENTER. A confirmation page will appear.
2. Press ENTER to delete all routes (or QUIT to cancel).

Once a route is added to memory, you can review and/or edit the route from the Route Edit Page. The Route Edit Page shows the sequence of waypoints for the selected route and provides additional options to insert waypoints, remove waypoints or perform trip/fuel planning functions.

To edit a route:

1. From the Route List, highlight the route you wish to edit and press ENTER. The Route Edit Page appears for the selected route.
2. To change a route waypoint, highlight the waypoint you wish to change and press ENTER. Use the rocker keypad to enter the new waypoint and press ENTER.
3. To review the information for a route waypoint, highlight the desired waypoint and press MENU. A pop-up menu appears with additional options. Highlight 'Review Wpt' and press ENTER to display the Waypoint Definition Page for the selected waypoint.
4. To insert a waypoint in the route, highlight the waypoint that will immediately follow the new route waypoint and press MENU. A pop-up menu appears with additional options. Highlight 'Insert Wpt' and press ENTER to display a blank line for the new waypoint. Enter the name of the new waypoint and press ENTER.
5. To delete a waypoint from the route, highlight the waypoint you wish to delete and press MENU. Highlight 'Remove Wpt' on the pop-up menu and press ENTER.

To edit a route from the map display:

1. Follow step 1 above to select the Route Edit Page, press MENU and select 'Show Map'.
2. To insert a new waypoint move the pointer to the route leg in which the new waypoint will be placed. press ENTER, move the pointer to the new waypoint location and press ENTER to insert the new waypoint.
3. To remove a waypoint, move the pointer to the waypoint, press MENU and select 'Remove Wpt'.



The Route Options allow for easy editing of an existing route.

| KIXD-KOSH | | Route Plan |
|-----------|----------|------------|
| Waypoint | Distance | |
| KIXD | 0.00m | |
| KIXD | 234m | |
| KOSH | 422m | |
| --- | n | |
| --- | n | TOTAL 422m |

To edit a route, highlight the route waypoint which is affected by the change. If inserting a waypoint, highlight the existing waypoint which follows the new waypoint.

REFERENCE

Route Editing

| KIXD-KOSH | | Route Plan |
|-----------|------------------|---------------------------|
| Waypoint | Course | |
| KIXD | 034 ^o | TOTAL 037 ^o |
| KCID | 046 ^o | |
| KOSH | --- | |
| ----- | --- | |
| ----- | --- | |

With a route displayed, use the LEFT/RIGHT keys on the rocker keypad to select the trip planning features.

| KIXD-KOSH | | Active Route |
|-----------|------------------|------------------|
| Waypoint | Distance | |
| KIXD | --- | |
| KCID | 230 ^m | |
| KOSH | 418 ^m | |
| ----- | --- | |
| ----- | --- | |
| TOTAL | | 418 ^m |

The Active Route Page shows the route currently being used for navigation guidance.

The Route Edit Page also displays trip planning information for each leg or the entire route. Available information includes desired course, time to waypoint, distance to waypoint, required fuel and sunrise/sunset times at the waypoint location.

To use the trip planning features:

1. To select the desired planning figure, highlight the desired route from the Route List and press ENTER to display the Route Edit Page. One of ten available planning figures appears to the right of each route waypoint. Use the LEFT/RIGHT keys on the rocker keypad to select the desired item.
2. To enter planning information, Press MENU and select 'Setup Plan' from the options list. Enter the figures for speed, fuel flow and departure date/time.

Active Route Page

The last page appearing in the main sequence (using the PAGE or QUIT keys) is the Active Route Page. Whenever you have activated a route, GOTO or TracBack, the Active Route Page will show each waypoint (by name) of the active route, along with the desired course, distance to waypoint, time to each waypoint, fuel requirements or sunrise/sunset times at each route waypoint. As you navigate the route, the information on the Active Route Page will automatically update to indicate the destination waypoint and any remaining interim waypoints.

From the Active Route Page, you can change the name of the active route (see page 67), review information on a route waypoint (see page 48) or bypass route waypoints and GOTO any waypoint in the route (see page 62). The user-selectable data field on the right side of the page also keeps you informed of current conditions. There are ten different data items available. See page 98 for descriptions of navigation terms.

To change the Active Route Page data, press the LEFT/RIGHT keys on the rocker keypad.

Active Route Page Options

Many features of the GPS III Pilot are menu driven. Each of the main pages has an options menu, allowing you to custom tailor the corresponding page to your preferences and/or select special features which specifically relate to that page.

To display the Active Route Page Options, press MENU (with the Active Route Page displayed).

The following options are available:

Setup Plan— displays a trip planning screen, allowing you to plan and review distance, fuel and time en route information for the selected route.

To use the trip planning features:

1. Highlight 'Setup Plan' and press ENTER. A setup screen is provided for planned speed, fuel flow and departure time.
2. To enter a speed for your trip, highlight the speed field, press ENTER and use the rocker keypad to select the desired speed. Press ENTER to confirm.
3. Enter an hourly fuel flow (if desired) in the fuel field, using the same steps above.
4. Enter the date and time of departure (the current date/time will be offered automatically), using the same steps above.
5. Press QUIT to return to the Active Route Page, and use the LEFT/RIGHT portion of the rocker keypad to select the planning figures (to the immediate right of each listed route waypoint's identifier).

Re-evaluate— reactivates the current route and selects the route leg closest to your current position as the active leg. The active leg defines the current 'from' and 'to' waypoints.

Deactivate— cancels navigation of the route you are currently using.



'Setup Plan' allows you to define planned speed, fuel flow and departure time in order to review trip planning figures.



'Re-evaluate' will reactivate the current route and select the closest leg. This feature is handy if you stray well off course and later wish to return to the route.

REFERENCE

Active Route Page Options



To reverse the sequence of waypoints in the active route, select the 'Invert' option.



To delete the active route from memory, select the 'Delete Route' option.

Invert— reactivates the current route in reverse order and navigates from the end waypoint back to the beginning waypoint.

Insert Wpt— allows you to insert an additional waypoint into the route, directly in front of the currently highlighted waypoint in the route. If no route waypoint is highlighted, this option is not available. See page 69 for route editing info.

Remove Wpt— removes the currently highlighted waypoint from the route. If no waypoint is highlighted, this option is not available. See page 69 for route editing information.

Review Wpt— allows you to view the Waypoint Definition Page for the currently highlighted waypoint in the route. If no route waypoint is highlighted, this option is not available. See page 48 for waypoint review information.

Delete Route— allows you to remove the current route from memory. The waypoints contained in the route will still appear in memory, but not as part of the route. See page 68.

Main Menu

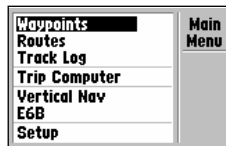

The GPS III Pilot's Main Menu provides access to the waypoint, route, track log, trip planning and setup features of the receiver. The Main Menu can be accessed at any time using the MENU key.

To display the Main Menu, press the MENU key twice.

The 7 menu options are divided into categories by function: waypoints/routes/track log, trip computer, vertical navigation/E6B and system setups.

To select an option from the Main Menu, highlight the desired item and press ENTER.

The following menu options are available:

Waypoints— allows you to review database information and create/edit/delete user waypoints. See pages 48-52 and pages 55-59.

Routes— allows you to create, edit, activate or delete routes. See pages 66-70.

Track Log— lets you specify whether or not to record a track log (an electronic 'breadcrumb trail' recording of your path) and defines how it is recorded. This submenu page also provides an indicator of the percentage of track memory used and options to clear the track memory or start a TracBack route. See pages 64-65 for TracBack information.

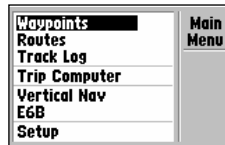

Press MENU twice to display the Main Menu.

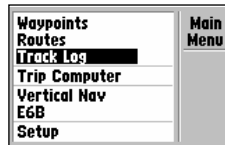

Select the desired menu option by highlighting it with the rocker keypad and pressing ENTER.

REFERENCE

Main Menu

| Track Log | |
|-------------|-------------|
| Memory Used | Record Mode |
| 21% | Fill |
| Clear Log | Off |
| TracBack | Wrap |

'Fill' will record track log data until memory is full, then provide a 'Track Memory Full' message.

| Track Log | |
|-------------|----------------|
| Memory Used | Record Mode |
| 0% | Fill |
| Clear Log | Interval |
| TracBack | Resolution |
| | Interval Value |
| | 82% |

To utilize the TracBack feature, you should clear the track log before leaving the departure airport.

Track Log Settings

Record Mode lets you select one of three track recording options:

'Off' – No track log will be recorded.



NOTE: Selecting 'Off' will prevent you from using the TracBack feature.

'Fill' – A track log will be recorded until the track memory is full.

'Wrap' (default) – A track log will be continuously recorded by wrapping through available memory and replacing the oldest track data with new data.

Interval defines the frequency with which the track plot is recorded. Three interval settings are available:

'Time' – Records track log based on a user-defined time interval.

'Resolution' (default) – Records track log based upon a user-defined variance from your course over ground. The resolution option is recommended for the most efficient use of memory and TracBack performance. The distance value (entered in the 'Interval Value' field) is the maximum left/right deviation allowed from the last defined ground track before recording a new point.

'Distance' – Records track log based on a user-defined distance between points.

Interval Value defines the distance or time interval used to record the track log.

Clear Log allows you to clear the track log data currently stored in memory.

To delete the track log data, highlight 'Delete Track' and press ENTER.

TracBack converts the track log data in memory into an inverted route and begins navigation along the route. See pages 64-65.

Trip Computer— provides readouts for average speed, maximum speed, odometer, trip odometer and trip timer. These readouts can be reset from the Trip Computer Options.

To reset a trip computer readout(s):

1. Press MENU (with the Trip Computer Page displayed). An options list is displayed.
2. To reset all trip computer readouts, highlight 'Reset All' and press ENTER.
3. To reset a single readout item, highlight the desired option and press ENTER.



NOTE: The 'Reset Trip' option resets trip odometer, trip timer and average speed readouts.

Vertical Nav— allows you to define a vertical navigation profile used to descend (or climb) to a target altitude at a specified location. See pages 43-45.

E6B— provides calculation features for density altitude, true airspeed and winds aloft. The winds aloft function will calculate wind direction, speed and the head/tail wind component.

To calculate density altitude and true airspeed:

1. Select the 'Density Altitude' file tab using the rocker keypad.
2. Highlight the 'Indicated Altitude' field and press ENTER. Enter the altitude from your altimeter and press ENTER.
3. Highlight the 'Calibrated Airspeed' field and press ENTER. Enter the airspeed from your airspeed indicator and press ENTER.
4. Highlight the 'Pressure' field and press ENTER. Enter the current altimeter setting (barometric pressure) and press ENTER.

| Trip Computer | |
|-------------------|------------------|
| Trip Odometer | Average Speed |
| 0.00 ^m | 0.0 ^h |
| Trip Timer | Maximum Speed |
| 00:00:00 | 0.0 ^h |
| Odometer | |
| | 0 ^m |

'Trip Computer' provides readouts for the trip odometer, trip timer, average speed and maximum speed. Options are provided to reset these figures.

| Density Alt Winds | |
|--------------------|---------------------|
| Indicated Alt | Calibrated Airspeed |
| 4500 ^h | 130 ^h |
| Pressure | Total Air Temp |
| 29.93 ^h | 79 ^h |
| Density Alt | True Airspeed |
| 6469 ^h | 143 ^h |

Density altitude and true airspeed may be calculated by entering values for indicated altitude, calibrated airspeed, barometric pressure and total air temperature.

REFERENCE

Main Menu / Setup

| Density Alt | | Winds | |
|-------------|---------------|-------|--|
| Heading | True Airspeed | | |
| 045° | 143% | | |
| Head Wind | | | |
| | 33% | | |
| Wind From | Wind Speed | | |
| 082° | 42% | | |

The 'Winds' option allows you to calculate the current headwind or tailwind component.

| | |
|---------------|-----------|
| Waypoints | Main Menu |
| Routes | |
| Track Log | |
| Trip Computer | |
| Vertical Nav | |
| EGB | |
| Setup | |

The 'Setup' option uses file tabs for quick selection/review of unit settings.

5. Highlight the 'Total Air Temperature' (TAT) field and press ENTER. Enter the TAT and press ENTER.



NOTE: TAT is the temperature of the air including the heating effect caused by speed. The temperature reading on a standard outside air temperature gauge found on most piston aircraft is TAT.

6. The 'Density Altitude' and 'True Airspeed' figures will appear at the bottom of the page.

To calculate winds aloft:

1. Select the 'Winds' file tab, using the rocker keypad.
2. Highlight the 'Heading' field and press ENTER. Enter the current aircraft heading and press ENTER.
3. Highlight the 'True Airspeed' field and press ENTER. Enter the current true airspeed and press ENTER. (If the true airspeed was previously determined on the 'Density Altitude' page, the calculated figure will automatically appear here as the default.)
4. The 'Head (Tail) Wind', 'Wind From' and 'Wind Speed' figures will appear at the bottom of the page.

Setup— provides a group of pages to perform various system setup functions, including selection of position format, units of measure, setting various alarms, configuring the display and backlighting. Each available page is denoted by a 'file tab' which identifies the function of that page.

To select a Setup option, highlight the file tab for the desired function. The information is automatically displayed when the file tab is highlighted.

REFERENCE

Setup

The file tab headings and setup functions for these pages are:

| | |
|-----------|--|
| Simulator | Enable/Disable; Settings for simulated track, speed and altitude |
| System | Backlight timeout, Battery type, Display Contrast and Orientation |
| Units | Units of measure settings for—Distance & Speed, Heading, Altitude, Pressure and Temperature |
| Timers | Count up/down User Timer, Battery Timer, and usage timers for current day and since new |
| Time | Formats for local 24 hour, local 12 hour (AM/PM) or UTC; Difference setting from UTC to local time |
| Alarms | Alarm Clock, Arrival Alarm, Off Course Alarm |
| Airspace | Airspace alarms for: Class B, Class C, Class D, Restricted Areas, MOAs, Other SUAs and Mode C Veils; Altitude buffer above/below airspace limits |
| Nearest | Runway surface type and Minimum Runway Length for nearest airport search |
| Position | Position Format (latitude/longitude, UTM/UPS, Maidenhead, regional grids); Map Datum selection |
| Interface | Format (NMEA, RTCM, GARMIN proprietary); Mode setting for use with PC or a second unit |

The following pages describe, in more detail, the available settings for each Setup file tab item.

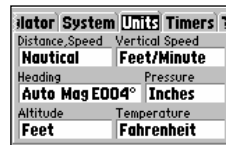

To display the desired information, highlight the appropriate file tab.

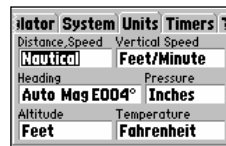

Once the desired information is selected, use the UP/DOWN keys on the rocker keypad to select the desired item on the page.

REFERENCE

Setup: Simulator

| Simulator | System | Units | Time |
|---------------------|--------|---------------|------|
| Mode | | Speed | |
| Simulator On | | 110.0% | |
| Track Control | | Track | |
| Auto Track | | 033° | |
| Altitude | | | |
| 536' | | | |

'Simulator' allows you to enable/disable the built-in simulator feature—and set simulated speed, track and altitude.

| Simulator | System | Units | Time |
|-----------|-------------------|---------------|------|
| M | | Speed | |
| S | Auto Track | 110.0% | |
| T | User Track | Track | |
| | Auto Track | 033° | |
| | Altitude | | |
| | 536' | | |

The "Track Control" setting allows the simulator to automatically "line up" on the correct bearing to a destination waypoint.

Simulator Settings

Mode lets you turn the built-in simulator on or off.

To enable/disable the built-in simulator:

1. Highlight the 'Mode' field and press ENTER.
2. Select 'Simulator Off' or 'Simulator On' (as desired) and press ENTER.

Speed lets you select a simulated speed when the simulator is enabled.

Track Control allows the built-in simulator to automatically align track heading to the desired course (when using a GOTO or route), or it allows you to manually adjust the track heading, as desired.

Track allows you to manually enter a track heading. This setting is only available when Track Control is set to 'User Track'.

Altitude allows you to specify a user-defined altitude for your simulated position.

To select a simulator setting:

1. For track control, highlight the 'Track Control' field and press ENTER. Select 'Auto Track' or 'User Track' and press ENTER.
2. For simulated speed, user track, or altitude, highlight the desired field and press ENTER. Enter the desired value using the rocker keypad and press ENTER when finished.

System Settings

Backlight lets you keep the screen/keypad backlighting on continuously ('always on') when selected, or enables the automatic shutoff to preserve battery life. Automatic shutoff times from 15 seconds to 4 minutes (since last key press) are available.

To set the backlight timeout:

1. Highlight the 'Backlight' field and press ENTER.
2. To keep backlighting on continuously, select 'Always On' and press ENTER. **Or**,
3. To set a timeout duration, select the desired time period and press ENTER.



NOTE: Backlighting timeout is automatically disabled when using external power.

Battery is used to designate the type of batteries currently being used to power your GPS III Pilot: Alkaline, Lithium or NiCad. This setting ensures accurate readings from the battery gauge on the Satellite Status Page (see page 29).

Contrast lets you adjust the screen for optimum viewing in all lighting conditions. Screen contrast is set using an on-screen bar scale. Contrast can also be set from the Satellite Status Page, as described on page 27.

To set the screen contrast:

1. Highlight the 'Contrast' field and press ENTER.
2. Use the LEFT/RIGHT keys on the rocker keypad to select desired level and press ENTER.

Display allows you set the display orientation to horizontal ('Landscape') or vertical ('Portrait').



NOTE: Display orientation can also be changed by pressing and holding the PAGE key.

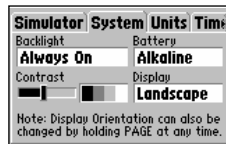

You can adjust the screen contrast from the Satellite Status Page or from the 'System' settings.

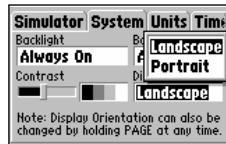

Display orientation is adjustable by pressing/holding the PAGE key or from the 'System' settings.

REFERENCE

Setup: Units

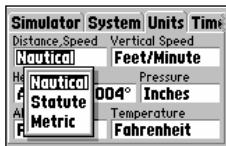

Select nautical, statute or metric units of measure from the 'Units' settings.



The 'User Mag' option allows you to define the magnetic variation for your area. 'Auto Mag Var' is the preferred setting in most cases.

Units Settings

Distance & Speed lets you select the desired units of measure for distance and speed readouts in 'Nautical', 'Statute' or 'Metric' terms.

Heading lets you select the reference used in calculating heading information. You can select from 'Auto Mag Var', 'True', 'Grid' and 'User Mag Var'. 'Auto Mag Var' provides magnetic north heading references which are automatically determined from your current position. 'True' provides headings based upon a true north reference. 'Grid' provides headings based on a grid north reference (and is used in conjunction with the grid position formats described on page 84). 'User Mag Var' allows you to specify the magnetic variation at your current position and provides magnetic north heading references based upon the variation you enter.

Altitude lets you select altitude readouts in 'Feet' or 'Meters'.

Vertical Speed lets you select a vertical speed in 'Feet/Minute' or 'Meters/Minute'.

Pressure lets you select altimeter settings (barometric pressure) in 'Inches' or 'Millibars'.

Temperature lets you select temperature readouts in degrees 'Fahrenheit' or 'Celsius'.

To select a units setting:

1. Highlight the desired field and press ENTER to display the available options.
2. Select the desired option and press ENTER.
3. If 'User Mag Var' is selected in the 'Heading' field, highlight the heading reference field (immediately to the right) and press ENTER. Enter the magnetic variation at your current position using the rocker keypad and press ENTER.



WARNING: If 'User Mag Var' is selected, you must periodically update the magnetic variation as your position changes. Using this setting, the GPS III Pilot will not automatically calculate and update the magnetic variation at your present position. Failure to update this setting may result in substantial differences between the information displayed on your GPS III Pilot and external references, such as a magnetic compass.

Timers Settings

User Timer lets you select a count up or count down timer. For a count down timer, you may also specify the count down duration.

To select a user timer setting:

1. For a count down timer, highlight the 'User Timer' field in the right-hand column, press ENTER and enter the count duration using the rocker keypad. Press ENTER to accept. Then (with the left-hand column highlighted) press ENTER to view the User Timer options. Select 'Down' and press ENTER.
2. For a count up timer, highlight the 'User Timer' field in the left-hand column, press ENTER and select 'Up'. Press ENTER to confirm.
3. To reset the timer or turn the timer off, highlight the 'User Timer' field in the left-hand column, press ENTER and select 'Reset' or 'Off' (as appropriate). Press ENTER to confirm.

Battery Timer provides a running count of how long the GPS III Pilot has been in operation with the current batteries. The timer automatically stops when using an external power source. The timer will automatically reset when depleted batteries are replaced, but can also be manually reset.

To select a battery timer setting:

1. Highlight the 'Battery Timer' field in the right-hand column and press ENTER.
2. Select 'Off', 'On' or 'Reset' (as appropriate) and press ENTER.

Since Midnight provides a running count of how long the GPS III Pilot has been in operation since midnight of the current day.

Since Factory Reset provides a running count of total GPS III Pilot operating time since the receiver was shipped from the factory.



The 'User Timer' option provides both count up and count down timers.



The battery timer will automatically reset when depleted batteries are replaced with a fresh set.

REFERENCE

Setup: Time

| System | Units | Timers | Time | f |
|-----------------|-------|------------|------|---|
| Time Format | | | | |
| Local 24hr | | | | |
| Local Time Zone | | | | |
| 05:00 | | Behind UTC | | |
| Time | | Date | | |
| 05:37:28 | | 25-JUL-97 | | |

Enter an offset amount to adjust the time display to your local area. In the United States, all offset amounts will be 'Behind UTC'.

| System | Units | Timers | Time | f |
|-----------------|-------|------------|------|---|
| Time Format | | | | |
| Local 24hr | | | | |
| Local Time Zone | | | | |
| Local 24hr | | Behind UTC | | |
| Local 12hr | | UTC | | |
| Time | | Date | | |
| UTC | | 25-JUL-97 | | |

If you're unsure of the exact offset select a 'Local' time format, then enter offset values until you arrive at the correct local time.

Time Settings

Time Format allows current time to be displayed using a 12- or 24- hour clock. This field is also used to select between local and UTC time readouts.

To select a time format:

1. Highlight the 'Time Format' field and press ENTER to display the available options.
2. Select 'Local 24hr' or 'Local 12hr' to display local time references. 'Local 12hr' will show current time using a traditional AM/PM format. **Or,**
3. Select 'UTC' to display universal time references (also referred to as 'Greenwich' or 'zulu' time).

Local Time Zone is used to define the current local time. UTC date and time are calculated directly from the satellites' signals and cannot be edited. If you prefer to use local time, you may designate an offset, either 'Behind UTC' or 'Ahead of UTC'. The offset is the difference, in hours and minutes, between local time and UTC time.

To enter the local time zone:

1. Highlight the 'Local Time Zone' field and press ENTER.
2. Select the desired offset amount (in hours and minutes) using the rocker keypad and press ENTER.
3. Highlight the offset direction field (immediately to the right) and press ENTER.
4. Select 'Behind UTC' or 'Ahead of UTC' (as appropriate) and press ENTER.

Time displays the current time based on the settings made above and information provided by the satellites received.

Date displays the current date based on the settings made above and information provided by the satellites received.

Alarms Settings

Clock Alarm uses the internal clock to provide an 'Alarm Clock' message at the time you set.

To enable/disable the alarm clock:

1. Highlight the 'Clock Alarm' field and press ENTER.
2. Select 'On' or 'Off' (as desired) and press ENTER.
3. If enabling the alarm, highlight the time field (to the immediate right) and press ENTER. Enter the alarm time using the rocker keypad and press ENTER.



NOTE: The GPS III Pilot must be turned on when the alarm time is reached. Otherwise, the message will not occur.

Arrival Alarm provides an alarm message once you've come within a set distance from your destination waypoint. As you approach the destination waypoint, an 'Arrival at ____' message occurs when you are within the alarm distance you entered.

Off Course Alarm provides an alarm message ('Off Course Alarm') when you deviate off course beyond the specified limits.

To set the arrival and/or off course alarms:

1. Highlight the 'Arrival Alarm' or 'Off Course Alarm' field and press ENTER.
2. Select 'On' or 'Off' (as desired) and press ENTER.
3. If enabling the alarm, highlight the alarm distance field (to the immediate right) and press ENTER. Enter the alarm distance using the rocker keypad and press ENTER.

| Units | Timers | Time | Alarms |
|------------------|--------|--------|--------|
| Clock Alarm | | | |
| Off | | 00:00: | |
| Arrival Alarm | | | |
| On | | 10.00% | |
| Off Course Alarm | | | |
| Off | | 0.00% | |

An 'Approaching' message automatically appears one minute before reaching the destination waypoint. The arrival alarm allows you to set a distance-defined message.

| Units | Timers | Time | Alarms |
|-------------|--------|--------|--------|
| Clock Alarm | | | |
| Off | | 00:00: | |
| Off | | 10.00% | |
| On | | 2.00% | |

The 'Off Course Alarm' provides an alert if you drift off course beyond the limits you have set.

REFERENCE

Setup: Airspace

| Class B | Class C | Tower Zone |
|--------------|-----------------|------------|
| On | On | On |
| Restricted | Off | Other SUAs |
| On | On | On |
| Mode C Veils | Altitude Buffer | |
| Off | 200' | |

You may enable/disable the airspace alerts by the individual categories shown.

| Class B | Class C | Tower Zone |
|--------------|-----------------|------------|
| On | On | On |
| Restricted | MOAs | Other SUAs |
| On | On | On |
| Mode C Veils | Altitude Buffer | |
| Off | 00500' | |

The altitude buffer provides an added margin of safety beyond the floor/ceiling limits of a given airspace.

Airspace Settings

Class B is used to enable/disable alarms for Class B or CTA (ICAO control areas) airspace.

Class C allows you to enable/disable alarms for Class C or TMA (ICAO terminal control areas) airspace.

Tower Zone provides an alarm within a 4.3 nm radius from airports with control towers which are not associated with Class B or Class C airspace. (Typically referred to as Class D.)

Restricted allows you to enable/disable alarms for restricted areas.

MOAs lets you enable/disable alarms for military operations areas.

Other SUAs provides alarms for other special-use airspace categories including: training, caution, danger, warning and alert areas.

Mode C Veils provides an alarm within the outer limit of an airspace (usually Class B or C) where a Mode C altitude-encoding transponder is required.

Altitude Buffer expands the vertical range of an airspace, providing an added margin of safety. For example, if the buffer is set at 500 feet, and you are more than 500 feet above or below an airspace, you will not be notified with an alert message. If you are less than 500 feet from the floor/ceiling limits of the airspace, you will be notified with an alert message. The default setting for the altitude buffer is 200 feet.

To turn an airspace alarm on or off and enter an altitude buffer:

1. Highlight the desired airspace category or the 'Altitude Buffer' field and press ENTER.
2. For airspace alarms, select 'On' or 'Off' and press ENTER.
3. For the altitude buffer, enter the desired buffer distance and press ENTER.



NOTE: Alarms for prohibited areas are always on. Disabling any of the above listed airspace categories only removes the alert. The boundaries will still appear on the map display.

Airspace Settings (cont.)

The airspace alarms are designed to provide message alerts in several stages, depending on whether you are projected to enter the airspace or are just in close proximity. The alerts are:

- **Airspace Ahead, Less Than 10 minutes** — occurs if your projected course will take you inside an airspace within the next ten minutes.
- **Airspace Near and Ahead** — is displayed when you are within two nautical miles of an airspace and your current course will take you inside the airspace.
- **Inside Airspace** — occurs when you have entered the boundaries of the airspace.
- **Near Airspace, Less Than 2 nm** — appears when you are within two nautical miles of an airspace, but your current course will not take you inside the airspace.



NOTE: Some airspace altitude limits may be charted in terms of altitude above ground level (AGL). If the actual lower limit of an airspace is charted in AGL, the GPS III Pilot will alert you at any altitude below the upper limit. However, if the actual upper limit is also charted in AGL, the GPS III Pilot will provide the alert at all altitudes.

Nearest Settings

Runway Surface determines which surface type or types will be included when displaying nearest airports on the Nearest Page. Available types include: 'Any' (includes water landing facilities), 'Hard Only' surface, 'Hard or Soft' surface and 'Water Only' facilities.

Min Runway Length determines the minimum allowable runway length when displaying nearest airports on the Nearest Page.

To select the nearest airport criteria:

1. Highlight the 'Runway Surface' or 'Min Runway Length' field and press ENTER.
2. For 'Runway Surface', select the desired surface type and press ENTER.
3. For 'Min Runway Length', enter the minimum allowable runway length and press ENTER.



Due to vertical airspace limits, if you fly above or below an airspace then descend or climb into the airspace, the 'Inside Airspace' message may be the only alert provided.



'Hard Only' includes only concrete, asphalt, or similar sealed surface runways.

REFERENCE

Setup: Position



Only the latitude/longitude, UTM/UPS and Maidenhead settings apply worldwide. The additional grid settings are only valid for a specific region.



Over 100 different datums are provided to allow the GPS III Pilot to correspond to various paper charts. Use WGS 84 unless your chart specifies otherwise.

Position Settings

Position Format is used to change the coordinate system in which a given position reading is displayed. The default format is latitude and longitude in degrees and minutes (hddd°mm.mmm'). The following additional formats are available:

- hddd.dddd° — latitude/longitude in decimal degrees only
- hddd°mm'ss.s" — latitude/longitude in degrees, minutes, seconds
- UTM/UPS — Universal Transverse Mercator / Universal Polar Stereographic grids
- British Grid
- German Grid
- Irish Grid
- Swedish Grid
- Swiss Grid
- Taiwan Grid
- Maidenhead

Map Datum allows you to select the datum reference used to determine where a given position is. The default setting is 'WGS 84'. Although over 100 datums are available (as listed on page 95), you should only change the datum if you are using a map or chart that specifies a different datum. If no datum is specified, you may select each datum applicable to your region until you find the datum that provides the best positioning at a known point.



WARNING: Selecting the wrong map datum can result in substantial position errors. When in doubt, use the default WGS 84 datum for best overall performance.

To change the position format and/or map datum:

1. Highlight the 'Position Format' or 'Map Datum' field and press ENTER.
2. Select the desired setting (using the rocker keypad) and press ENTER.

Interface Settings

Format lets you control the input/output format used when connecting your GPS III Pilot to external NMEA devices, a DGPS beacon receiver, or a personal computer, etc. Five format settings are available:

- **Aviation In** — allows the GPS III Pilot to communicate with a GARMIN panel-mounted GPS. Flight plans (or GOTO destinations) selected on the panel-mounted GPS will also appear on the GPS III Pilot.
- **GARMIN** — the proprietary format used to exchange waypoint, route, track log data with a PC or with another GPS III Pilot.
- **NMEA** — supports the input/output of standard NMEA 0183 version 2.0 data.
- **None** — provides no interfacing capabilities.
- **RTCM/NMEA** — allows Differential GPS (DGPS) input using a standard RTCM format and also provides NMEA 0183 version 2.0 output.
- **RTCM In** — allows DGPS input using a standard RTCM format, without any output capabilities.

To select an input/output format:

1. Highlight the 'Format' field and press ENTER.
2. Select the desired setting and press ENTER.
3. If the 'GARMIN' format is selected, highlight the 'Transfer Mode' field and press ENTER. Select the desired setting and press ENTER. The 'Transfer Mode' field allows you to specify what information to request or send to a second GPS III Pilot. The 'Host' setting lets you control all data transfer functions from the second GPS III Pilot or from a PC.
4. If an 'RTCM' format is selected, additional fields are provided to control a GARMIN differential beacon receiver (such as GARMIN's GBR 21) directly from your GPS III Pilot. You can enter the beacon frequency and bit rate on the GPS III Pilot and the information will be used to tune the beacon receiver. For more information, refer to the owner's manual for your beacon receiver.

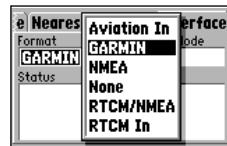

The 'GARMIN' option allows the GPS III Pilot to exchange data with a PC or another GPS III Pilot. Use this setting to perform database updates.



When transferring data to/from another unit, select the type of data and whether to 'request' it from or 'send' it to the other unit.

APPENDIX A

Mounting Instructions

The GPS III Pilot can be mounted on any flat surface using the two Velcro™ strips provided in the standard package, or you can use the supplied mounting bracket.

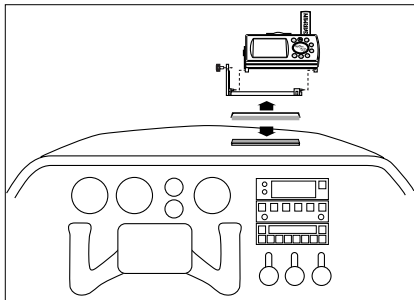
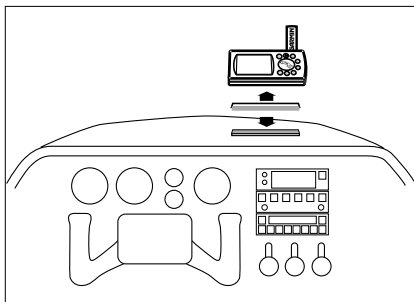

To mount the GPS III Pilot using the Velcro strips:

1. Select a location for the unit that provides a clear and unobstructed view of the sky for the GPS antenna, but will not obstruct your field of view while flying.
2. Make sure the surface to which you're adhering the Velcro is clean and dry. Remove the paper liners from both Velcro pieces.
3. Place the adhesive side of the rough piece of Velcro on the desired mounting surface, and press into place.
4. Place the adhesive side of the smooth piece of Velcro on the bottom of the unit (between the rubber anti-skid bumps), and press into place.
5. Mount the unit, placing one piece of Velcro on top of the other.

To mount the GPS III Pilot using the bracket:

1. Select a location for the unit that provides a clear and unobstructed view of the sky for the GPS antenna, but will not obstruct your field of view while flying.
2. Make sure the surface to which you're adhering the Velcro is clean and dry. Remove the paper liners from both Velcro pieces.
3. Place the adhesive side of the rough piece of Velcro on the desired mounting surface, and press into place.

- Place the adhesive side of the smooth piece of Velcro on the bottom of the bracket (inside the large rectangular recessed area), and press into place.
- Mount the bracket in place by placing one piece of Velcro on top of the other.

To insert the GPS III Pilot into the bracket:

- Remove the upper half of the mounting bracket by unscrewing the pivot knob (shown at bottom right) and sliding the upper bracket off the pivot pins of the lower bracket.
- Mate the two clips (opposite the thumb tab) on the upper bracket with the notches on the bottom of the GPS III Pilot.
- Rotate the GPS III Pilot into place in the upper bracket and snap the thumb tab clips into the notches on the top of the GPS III Pilot.
- For additional security, place the 3mm locking knob into the hole at the rear of the upper bracket and GPS III Pilot. (Use only the knobs supplied. Using incorrect hardware may damage the mount and/or GPS III Pilot.)

To reassemble the bracket and adjust viewing angle:

- Match the pin holes on the upper bracket with the pins on the lower bracket and slide together.
- Place the pivot knob through the side of the lower bracket and the screw into the upper bracket, but do not tighten.
- Rotate the upper bracket to the desired viewing angle and tighten the pivot knob.

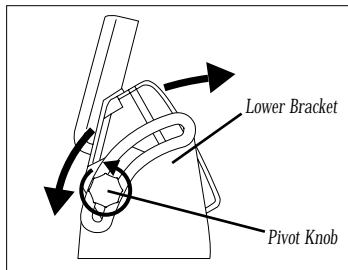
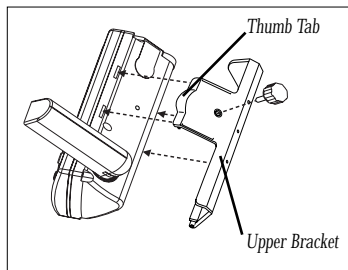

APPENDIX B

Specifications

The GPS III Pilot is constructed of high-quality materials and should not require user maintenance. If your unit ever needs repair, please take it to an authorized GARMIN service center. The GPS III Pilot has no user-serviceable parts. Never attempt any repairs yourself. To protect your GPS III Pilot, keep it in its carrying case (optional accessory) when not in use, and never allow gasoline or other solvents to come into contact with the case. To clean the case and lens, use a soft cloth and a household window cleaner.

PHYSICAL

Case: Fully-gasketed, high-impact plastic alloy;
waterproof to IPX7 standards

Size: 6.15"H x 2"W x 1.23"D (15.6 x 5.1 x 1.23 cm)

Weight: Approx. 9 ounces (255g) w/ batteries

Temperature Range: 5 to 158°F (-15° to 70°C)

Memory Back Up: Internal Lithium Battery

PERFORMANCE

Receiver: Differential-ready PhaseTrac12™

Acquisition Time: Approx. 15 seconds (warm start)
Approx. 45 seconds (EZinit/cold start)
Approx. 5 minutes (AutoLocate™)

Update Rate: 1/second, continuous

Specifications subject to change without notice.

* With optional GARMIN Differential GPS (DGPS) Beacon Receiver Input.

** Subject to accuracy degradation to 100m 2DRMS under the U.S. DoD-imposed Selective Availability Program.

† Alkaline batteries lose a significant amount of their capacity as temperature decreases. Use lithium batteries when operating the GPS III Pilot in below freezing conditions. Extensive use of screen backlighting will significantly reduce battery life.

Position Accuracy: 1-5 meters (3-15 ft) with DGPS
corrections*

15 meters (49 ft) RMS**

Velocity Accuracy: 0.1 knot RMS steady state

Dynamics: Performs to specification to 6g's

Interfaces: NMEA 183, RTCM in (for DGPS corrections),
Aviation in and RS-232 for PC interface

Antenna: Detachable with standard BNC connector

POWER

Input: Four 1.5-volt AA batteries or 10-32 VDC external

Power Consumption: 0.5 watts max.

Battery Life: Up to 24 hours †

Interfacing formats are selected from the Setup options, described on page 87. The input/output lines on your GPS III Pilot are RS-232 compatible allowing easy interface to a wide range of external devices, including PCs, differential beacon receivers, marine autopilots and/or a second GPS receiver.

The NMEA 0183 version 2.0 interface format is supported by the GPS III Pilot and enables the unit to drive up to three NMEA devices:

NMEA 0183 version 2.0 Approved sentences:

GPGGA, GPGLL, GPGSA, GPGSV, GPRMB, GPRMC, GPRTE, GPWPL, GPBOD

Proprietary sentences:

PGRME (estimated error), PGRMM (map datum), PGRMZ (altitude), PSLIB (beacon receiver control)

DGPS (Differential GPS) corrections are accepted in RTCM SC-104 version 2.0 format through the Data In line. The GARMIN GBR 21 is the recommended beacon receiver for use with the GPS III Pilot. Other beacon receivers with the correct RTCM format may be used, but may not correctly display status or allow tuning control from the GPS unit.

The GPS III Pilot may be hard-wired to a vehicle's electrical system (10-32 VDC) using an optional power/data cable. Consult the wiring diagram to the right for proper connections. (The male connector on the back of the GPS III Pilot is illustrated.) A cigarette lighter adapter is also available to power your GPS III Pilot without making permanent connections.

Additional cables are available to connect your GPS III Pilot to a PC-compatible computer's serial port (PC Interface Cable) or to connect to a second GPS III Pilot (Data Cross-Load Cable). Contact your GARMIN dealer for any of these accessories.

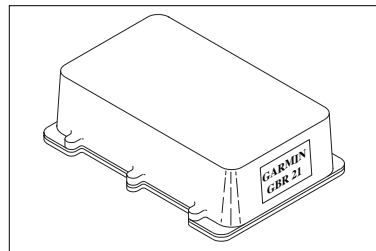

GARMIN GBR 21 Beacon Receiver

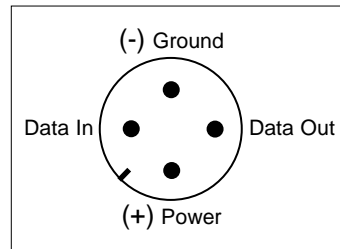

GPS III Pilot Connections (from back of unit)

APPENDIX D

Antenna / Remote Mounting

The GPS III Pilot's antenna may be removed to allow attachment of an optional remote-mounted antenna. In some applications, using a remote-mounted antenna will dramatically increase the number of satellites received. The GPS antenna should be mounted in a location which provides an unobstructed view of much of the sky. A minimum of four satellites are needed to determine a three-dimensional position. Satellite coverage will vary throughout the day, but may be checked at any time using the Satellite Status Page (see page 27). If satellite reception is limited in your particular installation, you may want to consider one of the following options:

Remote Suction Cup Mount – allows you to mount the standard detachable antenna up to 6 feet away from the GPS III Pilot unit, using a suction cup mount. This mount should only be used inside a vehicle.

GA 26 Remote Antenna – allows you to mount an amplified antenna outside the vehicle, up to 8 feet away, using supplied magnetic or suction cup mounts. Trunk lip and permanent flange mounts are also available.

GA 56 Low Profile Antenna - allows you to permanently mount an amplified antenna outside the aircraft, with a feed cable up to 60 feet in length.

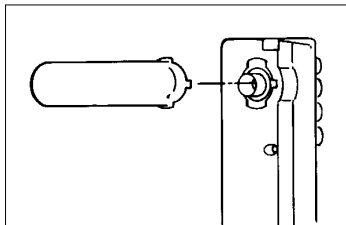

To remove the attached antenna:

1. Rotate the antenna toward the rear of the unit as shown.
Note: The antenna can only be removed or installed in this position.
2. Pull the antenna gently away from the unit.
3. To install an optional external antenna, mate the BNC connector notches with the mounting posts and turn the knurled knob one-quarter turn clockwise.

The GPS III Pilot uses an on-screen message indicator to alert you to important information. Whenever the message appears, press ENTER to acknowledge the message and return to the previous page you were viewing. Messages are provided for system status, waypoint/route editing, battery condition, etc. For your safety, pay careful attention to all messages.

Airspace Ahead, Less Than 10 minutes—Your projected course and current altitude will place you within an airspace in less than 10 minutes, based on your current track and speed.

Airspace Near and Ahead—Your present position is within 2 nm of an airspace, and you are projected to enter the airspace based on your current track, speed and altitude.

Alarm Clock—The alarm clock time that was set from the Alarms sub-menu has been reached.

Approaching—You are one minute away from reaching a destination waypoint.

Approaching Target Altitude—The current altitude is within 1000 feet of the final Vertical Nav target altitude.

Approaching VNav Profile—You are within one minute of reaching the initial Vertical Nav descent point.

Arrival at—You have reached your destination waypoint.

Battery Power Low—The batteries are low and should be replaced.

Can't Navigate Locked Route—You have attempted to navigate a route with a locked waypoint. A waypoint can be 'locked' when the database is updated if the waypoint does not exist in the new database.

Data Transfer Complete—The unit has finished uploading or downloading information to the connected device.

Degraded Accuracy—The unit's accuracy has been degraded beyond

500 meters due to poor satellite geometry or data quality. Check other navigational sources to verify the position indicated.

Inside Airspace—Your aircraft has entered the boundaries of special-use or controlled airspace.

Leg not Smoothed—The upcoming route leg is too short for smooth waypoint transitions.

Memory Battery Power Low—The battery that sustains user memory is low and should be replaced by an authorized service center as soon as possible. Failure to do so may result in loss of stored data, including all user waypoints and routes.

Near Airspace, Less Than 2 nm—Your position is within 2 nautical miles of an airspace and your current course will not take you inside.

Need Altitude for 2D Nav—The unit needs altitude input in order to start and/or continue 2D navigation.

Need to Select Init Method—You must select an initialization method so the unit can locate satellites and obtain a fix.

No Differential GPS Position—Not enough data is available to compute a DGPS position.

No RTCM Input—Beacon receiver is improperly connected or baud rates do not match.

Off Course Alarm—You are left or right of course, beyond the limits set on the Alarms sub-menu.

APPENDIX E

Messages

Oscillator Needs Adjustment—The GPS III Pilot has detected excessive drift in its internal crystal oscillator which may result in longer acquisition time. The unit should be taken to an authorized GARMIN service center.

Poor GPS Coverage—The unit cannot acquire the necessary number of satellites to compute a position. Try another location with a clearer view of the sky.

Power Down and Re-init—The GPS III Pilot cannot calculate a position due to abnormal satellite conditions. Turn the unit off, and use other means to verify the last position shown. Try the unit again later, possibly in a different location.

RAM Failed—The GPS III Pilot has detected a failure in its internal memory. If the message persists, the GPS III Pilot is unusable and should be taken to an authorized GARMIN service center.

Received Invalid Waypoint—A waypoint was received during upload transfer that has an invalid identifier and/or position.

Receiver Failed—A failure in receiver hardware has been detected. If this message persists, do not use the unit and take it to an authorized dealer for repair.

ROM Failed—The permanent memory has failed and the unit is not operable. Take your unit to an authorized GARMIN dealer for repairs.

Route Already Exists—You have attempted to name a route with the same name currently in use for an existing route. Enter a different name for the route.

Route Full—You have attempted to add more than 30 waypoints to a route.

Route Memory Full—Route memory is full and no additional routes can be added from another GPS III Pilot or uploaded from a PC.

Route Waypoint Deleted—A route waypoint entered does not exist in the database and has been deleted from the route.

Route Waypoint Locked—A route waypoint was locked when the database was updated, since the waypoint does not exist in the new database.

Route Waypoint Moved—The waypoint was moved when waypoint data was added during a database update, from another GPS III Pilot or uploaded from a PC.

RTCM Input Failed—DGPS data being received has been lost. You are no longer receiving the beacon signal.

Searching the Sky—The GPS III Pilot is in searching the sky for almanac data or the unit is in AutoLocate mode.

Steep Turn Ahead—This message appears approximately one minute prior to a turn that requires a bank angle in excess of 25 degrees in order to stay on course.

Stored Data Lost—All waypoints, routes, time, and almanac data have been lost due to battery failure, or the receiver's memory has been cleared.

Timer Expired—The countdown timer has expired.

Track Memory Full—Track log memory, consisting of approximately 1900 track points, is full. Delete the track log data to make room for new entries or select the 'Wrap' recording option.

Waypoint Memory Full—You have used all 500 waypoints in memory. Delete unwanted waypoints to make room for new entries.

Waypoint Already Exists—The name you are entering already exists in the GPS III Pilot's memory.

The following are the map datums available for the GPS III Pilot. Menu Page abbreviations are listed first, followed by the corresponding map datum name and area. The default map datum for the GPS III Pilot is WGS 84.

| | | | |
|------------------------|---|-----------------------|---|
| Adindan | Adindan- Ethiopia, Mali, Senegal, Sudan | Carthage | Carthage- Tunisia |
| Afgooye | Afgooye- Somalia | CH-1903 | CH 1903- Switzerland |
| AIN EL ABD '70 | AIN EL ANBD 1970- Bahrain Island, Saudi Arabia | Chatham 1971 | Chatham 1971- Chatham Island (New Zealand) |
| Anna 1 Ast '65 | Anna 1 Astro '65- Cocos Isl. | Chua Astro | Chua Astro- Paraguay |
| ARC 1950 | ARC 1950- Botswana, Lesotho, Malawi, Swaziland, Zaire, Zambia, Zimbabwe | Corrego Alegre | Corrego Alegre-Brazil |
| ARC 1960 | ARC 1960- Kenya, Tanzania | Djakarta | Djakarta (Batavia)- Sumatra Island (Indonesia) |
| Ascnsn Isld '58 | Ascension Island '58- Ascension Island | Dos 1968 | Dos 1968- Gizo Island (New Georgia Islands) |
| Astro B4 Sorol | Astro B4 Sorol Atoll- Tern Island | Easter Isld 67 | Easter Island 1967 |
| Astro Bcn "E" | Astro Beacon "E"- Iwo Jima | European 1950 | European 1950- Austria, Belgium, Denmark, Finland, France, Germany, Gibraltar, Greece, Italy, Luxembourg, Netherlands, Norway, Portugal, Spain, Sweden, Switzerland |
| Astro Dos 71/4 | Astro Dos 71/4- St. Helena | European 1979 | European 1979- Austria, Finland, Netherlands, Norway, Spain, Sweden, Switzerland |
| Astr Stn '52 | Astronomic Stn '52- Marcus Island | Finland Hayfrd | Finland Hayford- Finland |
| Astrln Geod '66 | Australian Geod '66- Australia, Tasmania Island | Gandajika Base | Gandajika Base- Republic of Maldives |
| Astrln Geod '84 | Australian Geod '84- Australia, Tasmania Island | Geod Datm '49 | Geodetic Datum '49- New Zealand |
| Bellevue (IGN) | Efate and Erromango Islands | Guam 1963 | Guam 1963- Guam Island |
| Bermuda 1957 | Bermuda 1957- Bermuda Islands | Gux 1 Astro | Gux 1 Astro- Guadalcanal Island |
| Bogata Observ | Bogata Observatry- Colombia | Hjorsey 1955 | Hjorsey 1955- Iceland |
| Campo Inchspe | Campo Inchauspe- Argentina | Hong Kong '63 | Hong Kong '63- Hong Kong |
| Canton Ast '66 | Canton Astro 1966- Phoenix Islands | Hu-Tzu-Shan | Hu-Tzu-Shan- Taiwan |
| Cape | Cape- South Africa | | |
| Cape Canavrl | Cape Canaveral- Florida, Bahama Islands | | |

APPENDIX F

Map Datums

| | | | |
|-------------------------|--|-------------------------|--|
| Indian Bngldsh | Indian- Bangladesh, India, Nepal | NAD27 Canada | North American 1927- Canada and Newfoundland |
| Indian Thailand | Indian- Thailand, Vietnam | NAD27 Canal Zone | North Am. 1927- Canal Zone |
| Indonesia '74 | Indonesia 1974- Indonesia | NAD27 Caribbn | North American 1927- Caribbean (Barbados, Caicos Islands, Cuba, Dom. Rep., Grand Cayman, Jamaica, Leeward and Turks Islands) |
| Ireland 1965 | Ireland 1965- Ireland | NAD27 Central | North American 1927- Central America (Belize, Costa Rica, El Salvador, Guatemala, Honduras, Nicaragua) |
| ISTS 073 Astro | ISTS 073 ASTRO '69- Diego Garcia | NAD27 CONUS | North Am. 1927- Mean Value |
| Johnston Island | Johnston Island Kandawala- Sri Lanka | NAD27 Cuba | North American 1927- Cuba |
| Kerguelen Islnd | Kerguelen Island | NAD27 Grnland | North American 1927- Greenland (Hayes Peninsula) |
| Kertau 1948 | Kertau 1948- West Malaysia, Singapore | NAD27 Mexico | N. American 1927- Mexico |
| L. C. 5 Astro | Cayman Brac Island | NAD27 San Sal | North American 1927- San Salvador Island |
| Liberia 1964 | Liberia 1964- Liberia | NAD83 | North American 1983- Alaska, Canada, Central America, CONUS, Mexico |
| Luzon Mindanao | Luzon- Mindanao Island | Nhrwn Masirah | Nahrwn- Masirah Island (Oman) |
| Luzon Philippine | Luzon- Philippines (excluding Mindanao Island) | Nhrwn Saudi A | Nahrwn- Saudi Arabia |
| Mahe 1971 | Mahe 1971- Mahe Island | Nhrwn United A | Nahrwn- United Arab Emirates |
| Marco Astro | Marco Astro- Salvage Island | Naparima BWI | Naparima BWI- Trinidad and Tobago |
| Massawa | Massawa- Eritrea (Ethiopia) | Obsrvtorio '66 | Observatorio 1966- Corvo and Flores Islands (Azores) |
| Merchich | Merchich- Morocco | Old Egyptian | Old Egyptian- Egypt |
| Midway Ast '61 | Midway Astro '61- Midway | Old Hawaiian | Old Hawaiian- Mean Value |
| Minna | Minna- Nigeria | | |
| NAD27 Alaska | North American 1927- Alaska | | |
| NAD27 Bahamas | North American 1927- Bahamas (excluding San Salvador Island) | | |

| | | | |
|-------------------------|--|------------------------|--|
| Oman | Oman- Oman | | |
| Ord Srvy GB | Old Survey Grt Britn- England, Isle of Man, Scotland, Shetland Isl., Wales | | |
| Pico De Las Nv | Canary Islands | SW Base | Southwest Base- Faial, Graciosa, Pico, Sao Jorge and Terceira Islands (Azores) |
| Pitcairn Ast '67 | Pitcairn Astro '67- Pitcairn Isl. | Timbalai 1948 | Timbalai 1948- Brunei and E. Malaysia (Sarawak and Sabah) |
| Prov S Am '56 | Prov So Amrcn '56- Bolivia, Chile, Colombia, Ecuador, Guyana, Peru, Venezuela | Tokyo | Tokyo- Japan, Korea, Okinawa |
| Prov S Chln '63 | Prov So Chilean '63- S. Chile | Tristan Ast '68 | Tristan Astro 1968- Tristan da Cunha |
| Puerto Rico | Puerto Rico & Virgin Islands | Viti Levu 1916 | Viti Levu 1916- Viti Levu/ Fiji Islands |
| Qatar National | Qatar National- Qatar | Wake-Eniwetok | Wake-Eniwetok- Marshall Isl. |
| Qornoq | Qornoq- South Greenland | WGS 72 | World Geodetic System 1972 |
| Reunion | Reunion- Mascarene Island | WGS 84 | World Geodetic System 1984 |
| Rome 1940 | Rome 1940- Sardinia Island | Zanderij | Zanderij-Surinam |
| RT 90 | Sweden | | |
| Santo (Dos) | Santo (Dos)- Espirito Santo Island | | |
| Sao Braz | Sao Braz- Sao Miguel, Santa Maria Islands (Azores) | | |
| Sapper Hill '43 | Sapper Hill 1943- East Falkland Island | | |
| Schwarzeck | Schwarzeck- Namibia | | |
| Sth Amrcn '69 | South American '69- Argentina, Bolivia, Brazil, Chile, Colombia, Ecuador, Guyana, Paraguay, Peru, Venezuela, Trinidad and Tobago | | |
| South Asia | South Asia- Singapore | | |
| SE Base | Southeast Base- Porto Santo and Madiera Islands | | |

APPENDIX G

Navigation Terms

Altitude—Height above mean sea level (MSL).

Avg Speed—The average of all second-by-second speed readings since last reset.

Bearing (BRG)—The compass direction from your present position to a destination waypoint.

Course—The desired course between the active 'from' and 'to' waypoints.

Distance (Dist)—The 'great circle' distance from present position to a destination waypoint.

Dist to Dest—The 'great circle' distance from present position to a GOTO destination, or the final waypoint in a route.

Dist to Next—The 'great circle' distance from present position to a GOTO destination, or the next waypoint in a route.

ETA—Estimate Time of Arrival. The estimated time you will reach your destination waypoint, based on current speed and track.

ETA at Dest—The estimated time you will reach a GOTO destination, or the final waypoint in a route.

ETA at Next—The estimated time you will reach a GOTO destination, or the next waypoint in a route.

Fuel—The fuel required to travel from present position to the indicated route waypoint.

Glide Ratio (GR)—The ratio of horizontal distance travelled to vertical distance travelled.

GR to Target—The glide ratio required to descend from present position and altitude to the target altitude at the location specified in the Vertical Nav settings.

Leg Dist—The distance between two route waypoints.

Leg Fuel—The fuel required to travel from a route waypoint to the next waypoint (in sequence) in the route.

Leg Time—The time required to travel from a route waypoint to the next waypoint (in sequence) in the route.

Max Speed—The maximum second-by-second speed recorded since last reset.

Odometer—A running tally of distance travelled, based upon the distance between second-by-second position readings. Both the 'Odometer' and 'Trip Odometer' are resettable, however the 'Odometer' is typically used to keep track of total distance covered, where the 'Trip Odometer' is used to keep track of shorter point-to-point distances.

Off Course—The distance you are off a desired course in either direction, left or right. Also referred to as 'cross-track error' or 'course error'.

Ref—Reference Waypoint. Used to create a new waypoint, by specifying a bearing and distance from an existing (reference) waypoint.

Speed—The current velocity at which you are travelling, relative to a ground position. Also referred to as 'ground speed'.

Time To—The estimated time required to reach a GOTO destination, or the next waypoint in a route. Also referred to as 'estimated time enroute'.

Time to Dest—The estimated time required to reach a GOTO destination, or the final waypoint in a route.

Time to Next—The estimated time required to reach a GOTO destination, or the next waypoint in a route.

Time to VNav—Prior to reaching the initial descent point, 'Time to VNav' indicates the time it will take to reach the initial Vertical Nav descent point. After passing the initial descent point, 'Time to VNav' indicates the time to reach the target altitude at the point specified in the Vertical Nav settings.

To Course—The recommended direction to steer in order to reduce course error or stay on course. Provides the most efficient heading to get back to the desired course and proceed along your route.

Track—The direction of movement relative to a ground position. Also referred to as 'ground track'.

Trip Odometer—A running tally of distance travelled since last reset. Also see 'Odometer'.

Turn—The angle difference between the bearing to your destination and your current track. 'L' indicates you should turn left, 'R' indicates you should turn right. The degrees indicate the angle you are off course.

VMG—Velocity Made Good. The speed you are closing in on a destination along a desired course. Also referred to as the 'vector velocity' to your destination.

VS to Target—The vertical speed required to descend from current altitude and position to the target altitude at the point specified in the Vertical Nav settings.

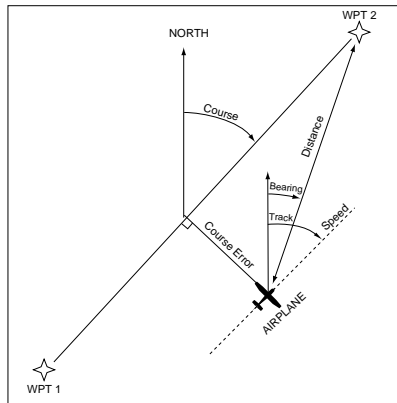
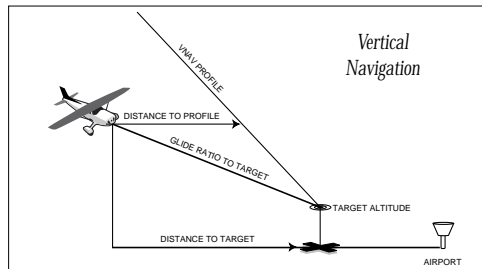

APPENDIX H

Index

A

| | |
|----------------------|----------|
| Active Route Options | 68-72 |
| Active Route Page | 16,70-72 |
| Active Waypoints | 48 |
| Airports | |
| Nearest | 25 |
| Warnings | 26 |
| Airspace | 26,84 |
| Alarms | 83 |
| Altitude Entry | 32 |
| Antenna, Removing | 92 |
| Arrival Alarm | 83 |
| AutoLocate™ Mode | 6,28 |
| AutoZoom | 38 |
| Averaging Positions | 33,55,60 |
| Averaging Speed | 32 |

B

| | |
|----------------------------------|---------|
| Backlight Timer | 79 |
| Backlighting On/Off | 30 |
| Battery Installation/Replacement | 3 |
| Battery Level Indicator | 8,29,69 |

| | |
|-----------------------|-------|
| Battery Type | 3 |
| Beacon Receiver Setup | 87 |
| Bearing | 98 |
| Bearing Pointer | 46 |
| Big Numbers | 11 |
| Bug Indicator | 22,40 |

C

| | |
|---------------|------|
| Cancel GOTO | 16 |
| Cautions | ii |
| Cities on Map | 39 |
| Contrast | 8,27 |
| Course | 98 |
| Course Error | 98 |
| Cursor | 2 |

D

| | |
|-----------------------------|----|
| D-bar | 11 |
| Data Entry | 2 |
| Database Info, viewing | 14 |
| Date and Time Setup | 82 |
| Default | 2 |
| Dilution of Precision (DOP) | 30 |
| Distance | 98 |

E

| | |
|---------------------------------|----|
| E6B | 75 |
| Enter/Mark Key | 2 |
| Estimated Position Error (EPE) | 30 |
| Estimated Time of Arrival (ETA) | 98 |

F

| | |
|-------|---|
| Field | 2 |
|-------|---|

G

| | |
|---------------|----------------|
| GOTO Function | 15,21,36,61-62 |
| GOTO/Nrst Key | 2 |
| GOTO Options | 63 |
| GPS Overview | 4 |

H

| | |
|----------------------|----------|
| Heading Selection | 80 |
| Highlight | 2 |
| Highway Display | 12 |
| Highway Page | 12,23,46 |
| Highway Page Options | 47 |
| HSI Page | 11,22,40 |
| HSI Page Options | 41-43 |

I

| | |
|-----------------------|----|
| Initialization | 5 |
| Installation, antenna | 92 |

| | |
|----------------------|-----|
| Installation, wiring | .91 |
| Interface Formats | .77 |
| Interface Settings | .87 |

K

| | |
|--------------|----|
| Keypad Usage | .2 |
|--------------|----|

L

| | |
|---------------|-----|
| Lakes on Map | .39 |
| Lat/Long Grid | .38 |

M

| | |
|-----------------------------|--------------|
| Main Menu Page | .13,73-76 |
| Map Datum List | .95-97 |
| Map Datum Selection | .86 |
| Map Orientation | .19 |
| Map Page | .10,19,35-36 |
| Map Page Options | .37-39 |
| Map Scale | .35 |
| Map Setup | .38 |
| Mark Position Page | .24 |
| Marking a Position | .14,24,55 |
| Maximum Speed | .98 |
| Measuring Between Waypoints | .37 |
| Menu Key | .2 |
| Messages | .93-94 |
| Mounting | .88-89 |

N

| | |
|-----------------------|-----------|
| Navigation Terms | .98-99 |
| Navigation Units | .80 |
| Nearest Airports | .25,53-54 |
| Nearest Waypoint List | .85 |
| NMEA Output Formats | .87 |

O

| | |
|--------------------|--------|
| Off Course | .83,98 |
| Offset, local time | .82 |
| Odometer | .72 |
| Output Setup | .87 |

P

| | |
|-----------------------|-----------|
| Package Contents | .i |
| Page Key | .1,2,7 |
| Page Sequence | .7 |
| Panning | .20,35-36 |
| Pointer Arrow | .11 |
| Position Averaging | .33 |
| Position Format | .86 |
| Position Page | .9,32 |
| Position Page Options | .33-34 |
| Power Key | .1,2 |
| Power Off | .2,6 |
| Power On | .2,5,17 |

Q

| | |
|----------|--------|
| Quit Key | .1,2,7 |
|----------|--------|

R

| | |
|---------------------|-----------|
| Railroads, on Map | .30 |
| Receiver Status | .8,27-29 |
| Reference Waypoints | .57 |
| Rivers, On Map | .38 |
| Roads, on Map | .38 |
| Rocker Keypad | .1,2 |
| Routes | .66-72 |
| Active Route Page | .71-72 |
| Activating | .67-67 |
| Copying | .68 |
| Creating | .66 |
| Deactivating | .67,71 |
| Deleting | .68-69,72 |
| Deleting All | .69 |
| Editing Routes | .69-70 |
| Inverting | .68,72 |
| List | .66-67 |
| Naming | .66-67 |
| Options | .66 |

APPENDIX H

Index

S

| | |
|-------------------------------|----------|
| Satellite Status Page | .8,27-29 |
| Satellite Status Page Options | .30-31 |
| Screen Contrast | .27,79 |
| Screen Orientation | .1,79 |

| | |
|----------------------|--------------|
| Scrolling | .2 |
| Setup Menu | .13,76-87 |
| Signal Strength Bars | .8,27 |
| Simulator Mode | .17-18,29,78 |
| Simulator Tour | .17-26 |
| Sky View Display | .8,27-28 |
| Specifications | .90 |
| Speed | .98 |
| Spell 'n Find | .57,61 |
| System Setup | .79 |

T

| | |
|---------------|-----|
| Time Format | .82 |
| Time Settings | .82 |
| Timers | .81 |

| | |
|---------------------|--------------|
| TracBack Navigation | .64-65 |
| Track Compass | .9,12 |
| Track Log Setup | .38,64-65,74 |
| Track Recording | .64-65,74 |
| Trip Computer | .75 |
| Trip Odometer | .9,85 |
| Trip Planning | .70-71 |
| Troubleshooting | .6 |
| Turn | .98 |

U

| | |
|------------------|-----|
| Unit Features | .1 |
| Units of Measure | .80 |
| UTC time | .82 |
| UTM Coordinates | .86 |

V

| | |
|----------------------------|-----------|
| Velocity Made Good (VMG) | .98 |
| Vertical Navigation (VNAV) | .44-45,75 |

W

| | |
|----------------|--------|
| Warranty | .iv |
| Waypoints | .48-60 |
| Categories | .48 |
| Comments | .59 |
| Create By Text | .56 |
| Create On Map | .56 |

| | |
|--------------------------|--------------|
| Deleting | .58,60 |
| Deleting All | .58 |
| Deleting by Symbol | .58 |
| Editing | .58-59 |
| Editing Options | .60 |
| Going to | .21 |
| Information Pages | .20,49-52 |
| List Options | .57-58 |
| Marking | .24,55 |
| Naming | .24,55-58 |
| Nearest | .25,48,51,64 |
| Options | .57 |
| Reference | .57 |
| Renaming | .58 |
| Reviewing | .48,73 |
| User-Defined | .55-57 |
| Waypoint Definition Page | .48,58 |
| Waypoint List Page | .73 |
| Wiring Installation | .91 |

Z

| | |
|-------------|--------------|
| Zoom In/Out | .10,19,35,40 |
| Zoom Keys | .2,35 |



© 1997-1999 GARMIN Corporation

GARMIN International, Inc., 1200 E. 151st Street, Olathe, KS 66062 USA

GARMIN (Europe) Ltd., Unit 5, The Quadrangle, Abbey Park Industrial Estate, Romsey SO51 9AQ UK

GARMIN (Asia) Corp., 3F No. 1, Lane 45, Pao-Hsing Road, Hsin Tien, Taipei, Taiwan R.O.C.

Web Site Address: www.garmin.com

Part Number 190-00127-00 Rev. B